

## 6. Compound Selection

### Operating conditions

The practical selection of a seal compound depends on an adequate definition of the operating conditions.  
In approximate order of application importance/

### Medium

The first thing to be considered when selecting a seal compound is its resistance to the fluids with which it will come in contact. This means all fluids, including the oil to be sealed, outside air, lubricants, and cleaning agents. For example, in a crankcase, raw gasoline, diesel fuel, gaseous products of combustion, acids formed in service, and water from condensation can be expected to contaminate the engine oil. In this case, the seal compound must be resistant to all fluids including the lubricant to be used on the seal. Therefore, whenever possible, it is a good practice to use the fluid being sealed as the lubricant, eliminating one variable. Consideration must also be given to the effect of the O-ring compound on system fluids. For example:

- There are some ingredients used in compounds which cause chemical deterioration of Freon refrigerants. When choosing a compound for use with Freon, it should not contain any of the ingredients which cause this breakdown.
- Compounds for food and breathing applications should contain only non-toxic ingredients.
- O-rings used in meters or other devices which must be read through glass, a liquid, or plastic, must not discolor these materials and hinder clear vision.

### Temperature

Temperature ranges are often over specified. Eriks has applied a realistic temperature range with a margin of safety when setting the general operating temperature range for seal compounds.

The maximum temperature recommendation for a compound is based on long term functional service. Since some fluids decompose at a temperature lower than the maximum temperature limit of the elastomer, the temperature limits of both the seal and the fluid must be considered in determining limits for a system.

At low temperature applications a few degrees may sometimes be gained by increasing the squeeze on the O-ring cross section. The low temperature limit on an O-ring seal may be compromised if the O-ring is previously exposed to a fluid that causes the O-ring compound to shrink. Conversely, the limit may be lowered if the fluid causes the O-ring to swell.

### 6. Compound Selection

#### Low Temperature

The low temperature limit is generally 10°C below TR-10 for static seals.

For dynamic seals the TR-10 is more relevant. The TR-10 is the temperature at which an elastomer is able to retract 10%.

Low temperature performance is generally a reversible process.

For design purposes compression is generally increased. The chemical media may cause swelling which may act as a plasticizer and lower the service temperature.

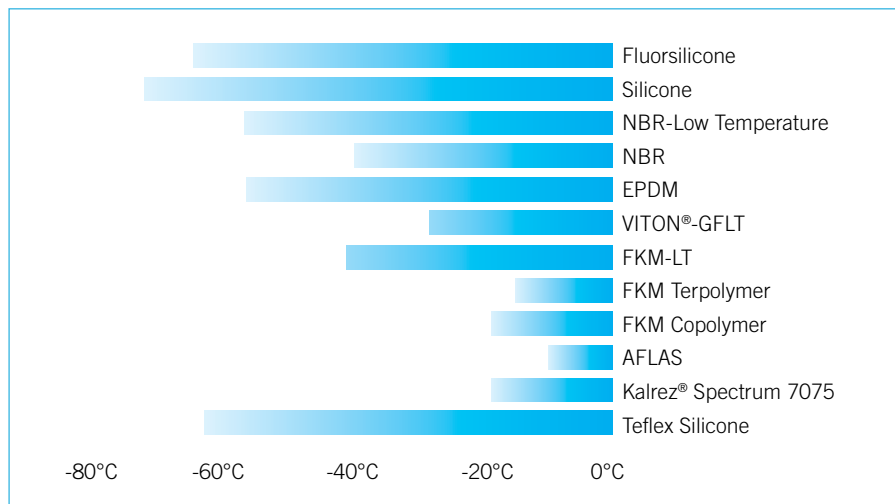

For cryogenic temperature, metal O-rings, see page 69

#### High Temperature

The high-temperature limit is generally considered a 30-50% loss of physical properties and typically represents a maximum temperature for 1,000 hours continuous service. It represents an irreversible change in the backbone or cross-link network. The effect of high temperature can be compounded by the interaction with the chemical media. Chemical reactions typically double with a 10°C increase in temperature.

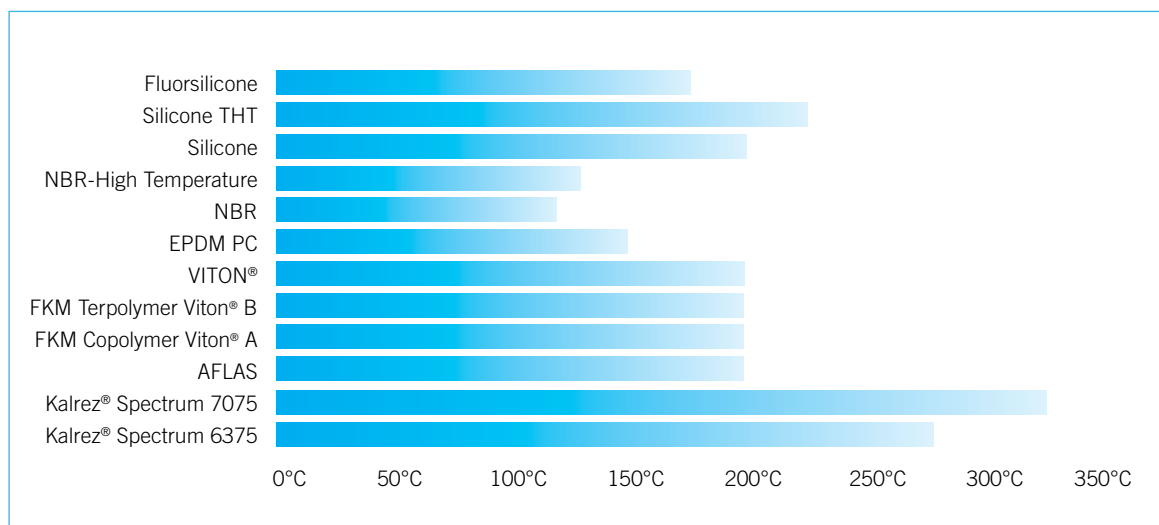

See °F/°C conversion table on page 249.

### 6. Compound Selection

#### Pressure

Pressure has a bearing on seal design as it may affect the choice of compound hardness. At very low pressures proper sealing may be more easily obtained with lower hardness. With high pressures, the combination of pressure and hardness control the maximum clearance that may safely be tolerated. Cyclic fluctuation of pressure can cause local extrusion of the seal, resulting in "nibbling", particularly if the peak pressures are high enough to cause expansion of the cylinder.

#### Time

The three obvious "dimensions" in sealing are, fluid, temperature, and pressure. The fourth dimension, equally important, but easily overlooked, is time. Temperature limits, both high and low, have been published at conventional short term test temperatures. These have little bearing on actual long term service of the seal in either static or dynamic applications.

For example, an industrial nitrile O-ring compound can be recommended to only 120°C (250°F), yet it is known to seal satisfactorily at 149°C (300°F) for 3000 hours and for five minutes at 538°C (1000°F).

Therefore, when the application requires a temperature higher than that recommended in the compound and fluid tables, check the temperature curve to determine if the total accumulated time at high temperature is within the maximum allowable limit.

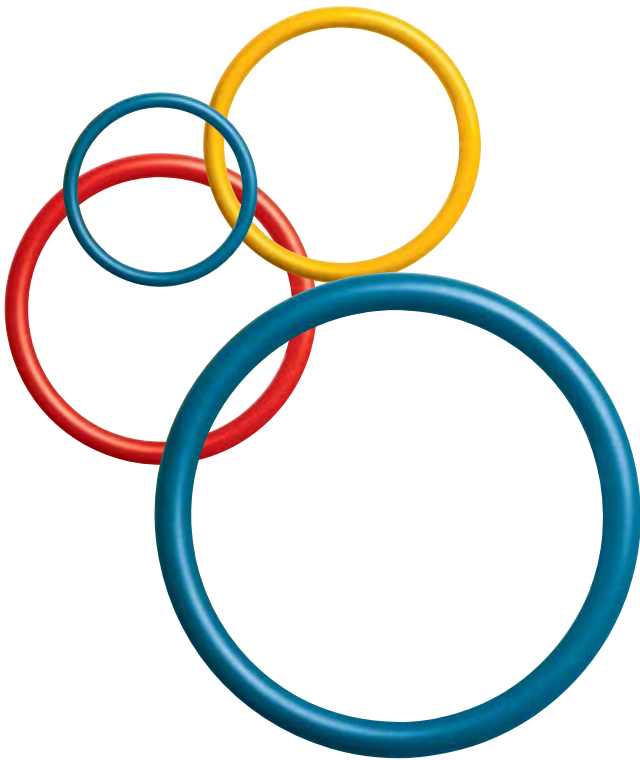

### 6. Compound Selection

We have over 130 different compounds for specific applications. Look at [www.o-ring.info](http://www.o-ring.info)

**TABLE 3A-2 STANDARD ERIKS COMPOUNDS**

Elastomer	Compound Number	Hardness Shore A±5	Temperature °C / °F	Application
Nitrile, NBR, Buna N	36624	70	-35 to +110 °C -31 to +230 °F	Hydraulic Oils, Vegetable Oils, Animal Fats, Acetylene, Alcohols, Water, Air, Fuels and many other products
	47702	90	-25 to +110 °C -13 to +230 °F	Chemical resistance of 36624 with higher hardness for higher pressure applications.
	Various			ERIKS is pleased to offer special compounds for special applications on request.
Ethylene Propylene, EPDM, EPM	55914	70	-55 to +130°C -67 to +266 °F	Solvents, alcohols, ketones, esters, organic and inorganic acids, hydraulic fluids. Highly age resistant. Not recommended for animal fats, vegetable or mineral oils.
	55914PC	70	-50 to +150 °C -58 to +302 °F	Chemical resistance of 55914 with improved temperature range and compression set characteristics. Also for steam applications.
	55918PC	80	-50 to +150 °C -58 to +302 °F	Chemical resistance of 55914 with higher hardness for higher pressure applications.
	Various			ERIKS is pleased to offer special compounds for special applications on request.
Silicone, VMQ	714177	70	-55 to +230 °C -67 to +446 °F	For extremely high or low temperature range, air, oxygen, dry heat, ozone, hot water to 302 °F (150 °C), and glycol based brake fluids. Resistant to hydraulic fluids but is not resistant to many hydraulic fluid additives. Silicones and Fluorosilicones are recommended only for static applications.
Fluorosilicone, FVMQ	614002	70	-50 to +220 °C -58 to +434 °F	Chemical resistance as noted above, with additional resistance to fuels and parafin based lubricants.
	Various			ERIKS is pleased to offer special compounds for special applications on request.
Fluorocarbon, FKM, Vitor®	51414 black and green	70	-20 to +200 °C -4 to +392 °F	Good chemical resistance to oils, fats, fuels. Has very low compression set characteristics at high temperatures. Suitable for vacuum applications.
	514320 black and green	90	-20 to +200 °C -4 to +392 °F	Chemical resistance of 51414 with higher hardness for higher pressure applications.
	Various.			ERIKS is pleased to offer a lot more standard compounds for special applications on request.
Perfluorocarbon, FFKM, Kalrez® Spectrum™	6375	75	-3 to +275 °C +27 to +527 °F	Broadest range of chemical and temperature resistance for chemical processing industry. Suitable for acids, basics, amines amines, steam, ethylene oxide and many other aggressive chemicals.
Kalrez® Spectrum™	7075	75	-4 to +327 °C -25 to +621 °F	High temperature compound with superb compression set characteristics and improved resistance against steam and amines. Very suitable for temperature cycle applications
Kalrez®	4079	75	-2 to +316°C +28 to +600°F	High temperature compound with superb compression set characteristics and poor resistance against steam and amines. Suitable for temperature cycle applications.
FFKM, Kalrez®	Various			ERIKS is pleased to offer special compounds for special applications on request.
Teflex FEP PFA	FKM Core		-20 to +200 °C -4 to +392 °F	High thermal and chemical resistance. Not recommended for dynamic applications. Cannot be stretched in installation.
	VMQ Core		-60 to +200 °C -76 to +392 °F +260°C (PFA)	Chemical resistance of FKM with improved compression set characteristics at low temperatures. Not recommended for vacuum applications due to high gas permeability. Not for dynamic applications.c

## 6. Compound Selection

### STANDARD ERIKS COMPOUNDS (VULC-O-RINGS)

Elastomer	Hardness Shore A $\pm 5$	Application
Silicone 75 FDA red 714006, 714206	75	For extremely high or low temperature range, air, oxygen, dry heat, ozone, hot water to 302 °F (150 °C), and glycol based brake fluids. Resistant to hydraulic fluids but is not resistant to many hydraulic fluid additives. Silicones and Fluorosilicones are recommended only for static applications. Food Quality FDA.
Fluorsilicone 75 Blue 614010	75	Solvents, alcohols, ketones, esters, organic and inorganic acids, hydraulic fluids. Highly age resistant. Not recommended for animal fats, vegetable or mineral oils.
EPDM 75 black 559303	75	Solvents, alcohols, ketones, esters, organic and inorganic acids, hydraulic fluids. Highly age resistant. Not recommended for animal fats, vegetable or mineral oils.
EPDM 75 FDA black 559187	75	Solvents, alcohols, ketones, esters, organic and inorganic acids, hydraulic fluids. Highly age resistant. Not recommended for animal fats, vegetable or mineral oils. Food Quality FDA/3A.
NBR 60 black 366304	60	Hydraulic Oils, Vegetable Oils, Animal Fats, Acetylene, Alcohols, Water, Air, Fuels and many other products.
NBR 75 black 366185	75	Hydraulic Oils, Vegetable Oils, Animal Fats, Acetylene, Alcohols, Water, Air, Fuels and many other products.
NBR 90 black 366303	90	Hydraulic Oils, Vegetable Oils, Animal Fats, Acetylene, Alcohols, Water, Air, Fuels and many other products.
HNBR 75 FDA black 886301	75	Better oil and temperature resistance than NBR.
PUR 75 black	75	Abrasion resistance.
AFLAS 75 black 223301	75	Highly steam resistant up to 200°C / 392°F
AFLAS 90 black 223302	90	Highly steam resistant up to 200°C / 392°F
Chloroprene 75 black	75	High ozone resistance.
Chloroprene 75 FDA black	75	High ozone resistance. Food Quality FDA.
Genuine Viton®	65-95	Large product family for different applications. The general-purpose types differ from the specialty types primarily in chemical resistance and low-temperature flexibility. In the speciality family, the choice is among types that are tailored for superior fluid resistance, low-temperature performance, or combinations of these properties. Learn more about the Viton® product family on the following pages.

### 6. Compound Selection - specials

#### For extreme services

Eriks offers a number of compounds for "extreme" services in their application field

- Different NBR, EPDM-compounds for specific applications
- Silicone THT for 280°C resistance
- Fluorosilicone 61370 and 61380 - to MIL-R-25988B
- Aflas® for optimum resistance to steam and crude oils
- HNBR for optimum hydraulic fluid resistance to 150°C - lowest compression set
- And many more...
- Over 250 data sheets are available upon request.

Ask our special edition  
on FDA and USP O-rings !



#### O-rings with homologations

ERIKS has developed a wide range of compounds for contact with food and pharma, drinking water, and gases

#### FDA & ADI

Neoprene 75-compound 329303  
 NBR 60-compound 366312  
 NBR 70-compound 366470  
 NBR 75-compound 366302  
 NBR 70 compound 366472  
 NBR 80 compound 366480  
 NBR 90 compound 366490  
 HNBR 70-compound 866172  
 HNBR 77-compound 886972  
 HNBR 69-compound 866214  
 EPDM 60-compound 559260  
 EPDM 60-compound 559311  
 EPDM 70-compound 55641  
 EPDM 70-compound 559270  
 EPDM 70-compound 559272  
 EPDM 70-compound 559273  
 EPDM 70-compound 55111  
 EPDM 70-compound 559274  
 EPDM 70-compound 559302  
 EPDM 75-compound 559291  
 EPDM 75-compound 559187  
 EPDM 75-compound 559280  
 Genuine Viton® 60-compound 514660  
 Genuine Viton® GLT 70-compound 514115  
 Genuine Viton® 70-compound 514670  
 Genuine Viton® 70-compound 514642  
 Genuine Viton® 70-compound 514672  
 Genuine Viton® 70-compound 514674  
 FKM A 70-compound 514328  
 FKM 75-compound 514010  
 Genuine Viton® A 75-compound 514304  
 Genuine Viton® A 75-compound 514172  
 Genuine Viton® A 75-compound 514641  
 Genuine Viton® 75-compound 514312  
 Genuine Viton® 80-compound 514682  
 Genuine Viton® GFS 75-compound 514683  
 Genuine Viton® 80-compound 514680  
 Teflex-Genuine Viton®  
 Genuine Viton® 90-compound 514690  
 Genuine Viton® 90-compound 514694  
 VMQ Silicone 40 714742  
 VMQ Silicone 40 714747  
 VMQ Silicone 40 714748  
 VMQ Silicone 60 714762

VMQ Silicone 60 714767  
 VMQ Silicone 60 714768  
 VMQ Silicone 60 714217  
 VMQ Silicone 70 714001  
 VMQ Silicone 69 714330  
 VMQ Silicone 70 714002  
 VMQ Silicone 75 714206  
 VMQ Silicone 75 714006  
 VMQ Silicone 80 714782  
 VMQ Silicone 80 714787  
 VMQ Silicone 80 714788  
 Teflex-VMQ Silicone  
 Kalrez® 70 6221  
 Kalrez® 75 6230  
**USP**  
 EPDM 70-compound 559273  
 EPDM 70-compound 559274  
 EPDM 70-compound 559302  
 EPDM 70-compound 559291  
 FKM 75-compound 514010  
 Genuine Viton® 75 514312  
 Teflex Viton®  
 FKM 60-compound 514767  
 FKM 60-compound 514217  
 FKM 70-compound 514001  
 VMQ Silicone 70 714001  
 VMQ Silicone 75 714002  
 Teflex-VMQ Silicone  
 Kalrez® 6221  
 Kalrez® 6230  
**KTW**  
 EPDM 70-compound 55111  
 EPDM 75-compound 559291  
 EPDM 70-compound 559310  
**WRAS**  
 EPDM 70-compound 55111  
 EPDM 75-compound 559291  
 EPDM 70-compound 559310  
**ACS**  
 EPDM 70-compound 55111  
 EPDM 75-compound 559291

**NSF**  
 EPDM 70-compound 55111  
 EPDM 75-compound 559291  
**3A**  
 NBR 60-compound 366312  
 NBR 70-compound 366470  
 NBR 75-compound 366302  
 EPDM 67-compound 559311  
 EPDM 70-compound 559273  
 EPDM 70-compound 559302  
 EPDM 75-compound 559291  
 EPDM 75-compound 559187  
 FKM 70-compound 514328  
 FKM 75-compound 514010  
 Genuine Viton® A 75-comp. 514304  
 Genuine Viton® 75-compound 514172  
 Genuine Viton® 75-compound 514312  
 Silicone 60 714217  
 Silicone 69 714330  
 Silicone 75 714006  
**EN 549**  
 NBR 70-compound 36625  
 NBR 70-compound 366300  
 Genuine Viton® GLT 75-comp. 514102  
**NEN**  
 NBR 70-compound 32770  
**GASTEC**  
 NBR 70-compound 32770  
**DVGW**  
 NBR 70-compound 366300  
 EPDM 70-compound 55111  
 EPDM 70-compound 559310  
 EPDM 75-compound 559291  
 Genuine Viton® GLT 75-comp. 514102  
**KIWA**  
 EPDM 70-compound 55111  
**W-270**  
 EPDM 70-compound 559310  
 EPDM 70-compound 55111  
**BfR**  
 VMQ Silicone 60 714217  
 VMQ Silicone 70 714001  
 VMQ Silicone 75 714002



### 6. Compound Selection - specials

#### O-rings and special applications

- X-rings
- Quad-Rings®/X-Rings
- Micro o-rings
- Vulc-O-rings
- Encapsulated o-rings
- PTFE O-rings
- PTFE back up rings
- NBR 90 back up rings
- Omniseals (with spring) PTFE
- High-purity compounds
- Silicone free
- Labsfree
- Plasma treated
- Coatings with silicone, PTFE, graphite
- With narrow tolerances
- With surface-control
- With homologations
- Internal lubricants (PTFE, graphite, MOS2)
- Eriflon® PTFE hydraulic seals

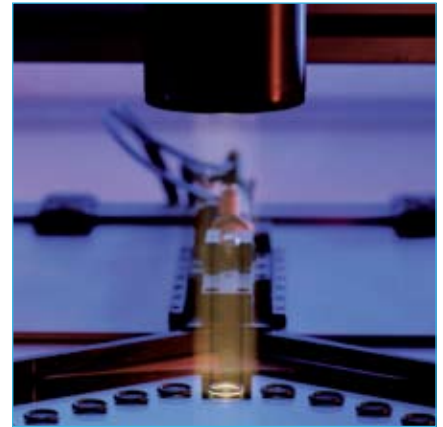

**ERIKS O-rings are made using the latest technology.**

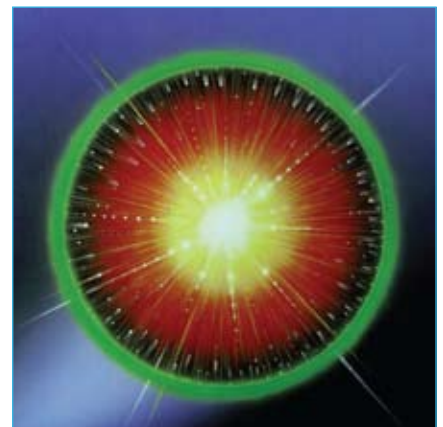



### 6. Compound Selection - Viton®

#### Genuine Viton®

##### 'Only the best is good enough for you'

Today's industry sometimes operates under extreme conditions. Heat, aggressive media, corrosive gasses, and mechanical stress require the utmost performance from seals. Extreme requirements demand quality assurance and the best materials. In many cases Genuine Viton® made by DuPont Performance Elastomers, is the solution. Genuine Viton® is manufactured with 100% pure fluoroelastomers and is certified with the Viton® certificate. ERIKS is appointed a licensed distributor for Genuine Viton® products.

#### How do I make sure that I've got Genuine Viton®?

Only products made of Genuine Viton® carry the specific, easy recognizable label on their package. With parts made of Genuine Viton® one can be assured that the product has been manufactured and processed by both DuPont Performance Elastomers and their licensed partners according to guidelines specified in the Materials Integrity Section of OSHA 1910.119 (Process Safety Management of Highly Hazardous Chemicals Preventive maintenance). Please ask for a copy of ERIKS' Genuine Viton® brochure.

#### The Viton® families

Viton® was introduced in 1958. There are now three major general used families of Viton® fluoroelastomer: A, B, and F. They differ primarily in their resistance to fluids, and in particular aggressive lubricating oils and oxygenated fuels, such as methanol and ethanol automotive fuel blends. There is also a class of high performance Viton® grades: GB, GBL, GF, GLT, GFLT, Extreme, and Base resistant.

Viton® is a registered trademark from DuPont Performance Elastomer.



Relative chemical compatibility and mechanical properties for Viton® fluoroelastomers

Chemical environment	Viton® General use types					Viton® Specialty types		
	A	B	F	GBL-S	GF-S	GLT-S	GFLT-S	ETP-S
Automotive and aviation fuels	1	1	1	1	1	1	1	1
Automotive fuels oxygenated with MEOH, ETOH, MTBE, etc	4	2	1	2	1	4	1	1
Engine lubricating oil, SE and SF	2	1	1	1	1	1	1	1
Engine lubricating oil, SG and SH	3	2	2	1	1	2	1	1
Aliphatic hydrocarbon process fluids, chemicals	1	1	1	1	1	1	1	1
Aromatic hydrocarbon process fluids, chemicals	2	2	1	1	1	2	1	1
Aqueous fluids, steam, mineral acids	3	2	2	1	1	1	1	1
Strong base, high pH, caustic, aminos	4	4	4	2	2	2	2	1
Low molecular weight carbonyls 100% concentrate (MTBB, MBK, MIBK, etc.)	4	4	4	4	4	4	4	1
<b>Compression set and low temperature performance</b>								
Resistance to compression set	1	2	2	2	2	2	2	2
Low temperature flexibility	2	2	3	2	3	1	1	2

Key: 1 = Excellent 2 = Fair 3 = Poor 4 = Not Recommended



### 6. Compound Selection - Viton®

End-use service differences between Types of Viton®

Standard and Speciality Types	Low Temp. Flexibility TR-10, °C	Compression Set, O-rings 70 h/200°C, %	Fluid Resistance % Volume Increase after 168 h				Base Resistance % loss of elongation at break	
			Toluene at 40°C	Fuel C/MeOH (85/15) at 23°C	Methanol at 23°C	Concentrated H2SO4 at 70°C	33% solution of KOH 336h/40°C	ASTM Ref. Oil 105 500h/150°
AL	-19	20-25	20-25	35-40	85-95	12-15	-50	-80
A	-17	12-17	20-25	35-40	85-95	10-12	-45	-80
BL, GBL-S	-15	25-40	12-15	20-25	25-35	3-5	-25	-65
B	-13	25-30	12-15	18-23	25-35	8-10	-25	-70
ETP-S	-11	45-50	6-8	8-10	1-2	4-6	0	-10
GFLT-S	-24	35-40	8-12	10-15	3-5	3-5	-30	-40
GBLT-S	-26	35-40	12-15	27-32	25-35	3-5	-40	-50
F	-8	30-45	8-12	5-10	3-5	7-9	-50	-55
GF-S	-8	30-45	8-12	5-10	3-5	7-9	-45	-50
TBR-S	+3	45-50	60-65	80-90	-	3-5	-10	-20

#### Viton® A-compounds for general use

ERIKS offers six standard O-ring compounds of which thousands of different sizes are available from stock. Please find the most important technical data for these compounds in Table 3A-2d.



Table 3A-2d Standard Genuine Viton® A compound

Technical data	51414 black	51414 green	514320 black	514670	514690	514206 black
Hardness IRHD ±5 DIN 53519	75	75	90	70	90	75
Tensile strength MPa.min. DIN 53504	13	12	14	16,9	14,8	10,7
Elongation % DIN 53504	170	170	120	261	119	213
Compression set % 24h/200°C						
on slab max. DIN 53517	12	14	14	15	12	7,5
on OR 3,53 mm max.	18	19	18			
Heat aging 70h/200°C						
Hardness DIN 53508	+4	+5	+5	-2	-1	+3
Low temperature TR-10 / ASTM 1329	-16°C	-16°C	-16°C	1,82	1,84	2,32
Density ASTM 1817	1,85	2,07	1,87	1,82	1,84	2,32
Max. temperature °C	+200	+200	+200	+200	+200	+200
Miscellaneous Information	stock	stock RAL 6011	stock in black, green on demand	FDA, 1 to 5 day production	FDA, 1 to 5 day production	1 to 5 day production, also Vulc-O-Ring

### 6. Compound Selection - Viton®

#### Petrochemical industry

Due to the permeability of O-ring compounds, high pressure gas can enter into the O-ring. There it builds microscopic bubbles between the molecular chains. Upon withdrawal of the pressure, the gas bubbles expand and cause cracks in the seal composition. ERIKS offers compounds based on Viton® A and Viton® B that meet the highest demands in these applications: high pressures, high temperatures, extrusion resistant, and explosive decompression resistant, for use in contact with natural gas, steam, and corrosion inhibitors, etc.

Obviously, for less critical applications our standard Viton® compounds are also perfectly suitable.

#### Food industry

ERIKS offers a number of compounds with approval for contact with food stuffs. These compounds meet the demands of the Code of Federal Regulations, title 21, Chapter 1, Subchapter B, Paragraph 177.2600 for use in contact with unpacked food stuffs.

For seals, two relevant FDA classes exist: Class 2 for contact with liquids and drinks and Class 1 for contact with milk, milk-derived products, and edible oils.

ERIKS standard Viton® FDA O-rings meet Class 1 requirements. ERIKS can offer the following approved O-rings for Class 1 compounds.

Consult our website [www.o-ring.info](http://www.o-ring.info) for our overview of compounds for the food and beverage industry.



These compounds are also animal derived ingredient free. ERIKS can also supply a number of compounds ranging from 60 to 95 IHRD, that also meet Class 2 requirements.

#### Low temperature applications

Fluoroelastomers do not really excel with regard to low temperature resistance. Standard Viton® A compounds are mostly applicable from -20°C (-4°F) on. Special low temperature Viton® compounds are Viton® GLT and GFLT. These compounds are in many applications suitable at low temperatures of -40°C (-40°F – Viton® GLT) and, with better chemical resistance, from approximately -35 to -30°C (-31 to -22°F – Viton® GFLT).



### 6. Compound Selection - Viton®

#### Special compounds

The following compounds can be applied under very specific circumstances. Only the main characteristics are described. More specific details are available upon request.

#### High Purity Compound

This compound offers a unique combination of chemical resistance and very good plasma resistance. Its contaminating substance content is up to 600 times lower than standard Viton®. It loses very little weight during plasma treatment and contains only one tenth of the surface uncleannesses in reactive plasma. Therefore, a typical compound for the semicon industry.

#### Note:

For very specific requirements, ERIKS can develop special Viton® compounds that meet unique demands even better than these compounds described here. Presently ERIKS has about 65 unique compounds that have already been applied successfully all over the world. It goes without saying that these are custom-made items which are usually not available from stock.

#### Vulc-O-rings

Viton® Vulc-O-rings are made out of very homogenous genuine Viton® O-ring cord with a hardness of 75 and 90 Shore A. The O-rings are made endless under a 45° biased angle, by means of a unique production process. The joint undergoes a follow-up treatment and is hardly visible. Every Vulc-O-ring is made according to ISO 3302/ M2F and E1. The O-ring cord has an extremely low compression set, resulting in a lifetime for Vulc-O-rings that exceeds the average for standard Viton® A O-rings.

#### Note:

In the next chapter "Frequently asked questions about Viton®" you will find a comparison table describing lifetime test results. After 3.000 hours at 390°F (200°C), the joint in the Vulc-O-ring showed the same elasticity value (compression set) as the original cord. This leads us to the conclusion that Vulc-O-rings can be considered equivalent to standard O-rings. A copy of the test report is available upon request.



### 6. Compound Selection - Viton®

#### Frequently asked questions about Viton®

##### 1. Does the compound colour affect the quality of the seal?

Our experience is that chemical and temperature resistance do not change. Mechanical properties of black compounds, however, are often much better than those of coloured compounds.

##### 2. Does the type of carbon black affect the quality of a seal?

Definitely! The standard MT990 carbon black filler offers very good results in all respects. Specific carbon black, such as e.g. Austin Black, can strongly improve the sealing properties. Our compound 514075 brown is made with Austin Black and shows the lowest values in all compression set tests. Other carbon blacks offer the advantage of higher tensile strength or wear resistance.

##### 3. How fast can you supply odd-size O-rings?

Through our unique vulcanisation process, ERIKS can supply any Vulc-O-ring within 48 hours, if required. Standard delivery time for odd-sizes is 1 to 2 weeks.

##### 4. What is post-curing?

After moulding, Viton® parts have to be post-cured at 200°C / 392°F for 8 to 24 hours, depending on the compound. Post-curing optimizes the vulcanisation, causing all links in the molecular structure to develop. The method of post-curing can strongly affect the final quality of the compound.

##### 5. Is there a difference in life among the various compounds?

ERIKS has subjected some of our compounds to life tests. The compression set was measured in air at 200°C / 392°F for 1.000 hours. One may assume that an O-ring has lost its sealing properties after the compression set has reached 100%. The following table gives an overview of four different compounds:

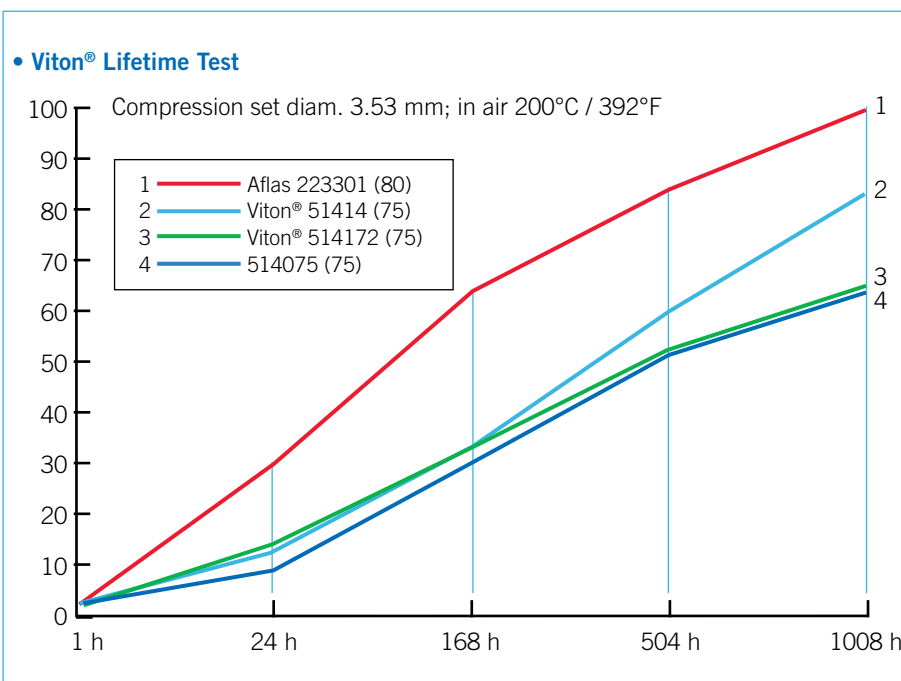
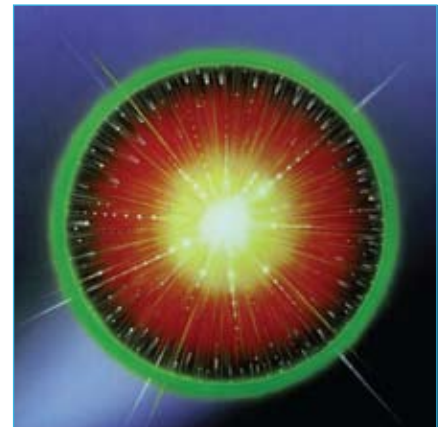

### 6. Compound Selection - Viton®

#### Frequently asked questions about Viton®

##### 6. What is the price difference among these various compounds?

It is difficult to give an exact answer because prices highly depend on size and production quantities. As a guideline, one may use the following chart:

Compound	Price Factor
Viton® A - standard	1
Viton® B	5
Viton® GF	10
Viton® Extreme ETP	50



##### 7. How does media temperature affect the life of a Viton® seal?

The life of a seal is strongly affected by media temperature. ERIKS has measured the time after which the elongation at break is reduced to 50%, at different media temperatures. Following are the results, these are only applicable to Genuine Viton® compounds.

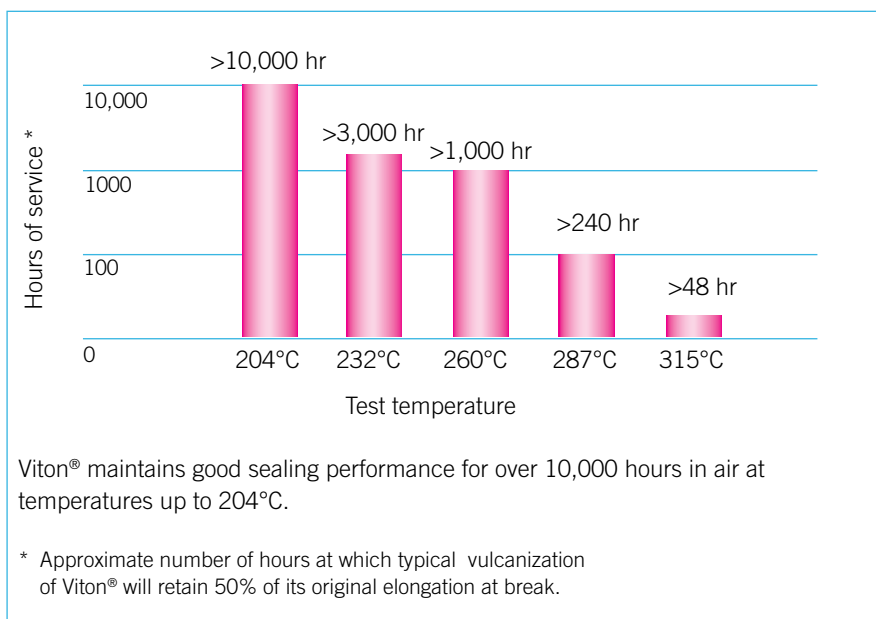

##### 8. How do I learn about the chemical resistance of a Viton® seal?

ERIKS will gladly send out an updated chemical resistance list, upon request. A summarized list is included in this brochure. Since ERIKS is in close contact with DuPont Performance Elastomers' laboratory in Geneva and Switzerland, we are always assured of possessing the latest data. In our own test laboratory, we can also organise specific tests with our Viton® compounds in media provided by our customers. Visit the DuPont Performance Elastomers website for the latest details on chemical resistance. [www.dupontelastomers.com/crg](http://www.dupontelastomers.com/crg)



## 6. Compound Selection - Viton®

### Frequently asked questions about Viton®

#### 9. When should I choose Kalrez®?

Kalrez® is a perfluoroelastomer and, as such, offers chemical and temperature resistance of a different grade, compared to Viton®. Please consult the local ERIKS office for more specific information about this “top of the list” problem solver. Following are the results of compression set tests with Viton® and Kalrez®.



Long term sealing force retention at 204°C

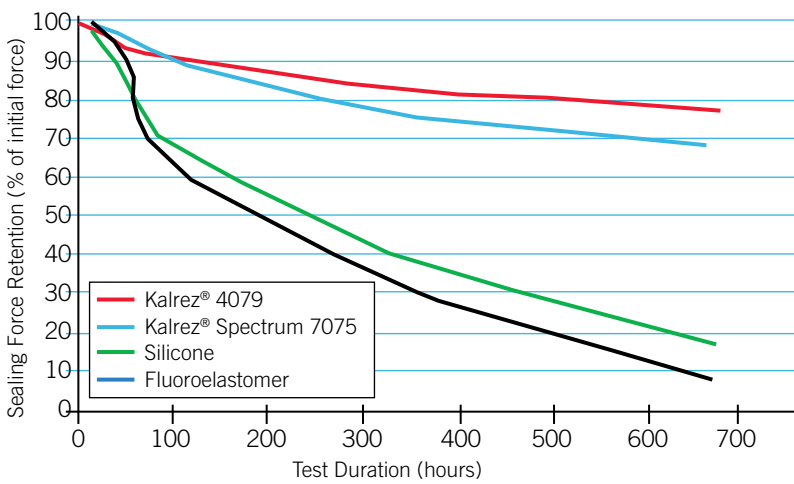

This test proves Kalrez® has a much longer sealing capability than other high temperature elastomers at 204°C/400°F.



### 6. Compound Selection - Viton®



#### ERIKS and DuPont Performance Elastomers: Over 25 years of partnership

For 25 years Eriks and DuPont Performance Elastomers have been partners in the production and marketing of original Viton® and Kalrez® High-Tech rubber compounds.

Eriks produces sealing parts made of genuine Viton®. Eriks guarantees quality from the raw material to the end-product, for critical applications that demand the best seals. All information on Viton® fluoroelastomers and Kalrez® perfluoroelastomers can be found in two different Eriks publications, summarizing the various types, compounds, and applications.

The many case studies described in the publications, may offer suggestions for alternative uses for Viton® and Kalrez®.

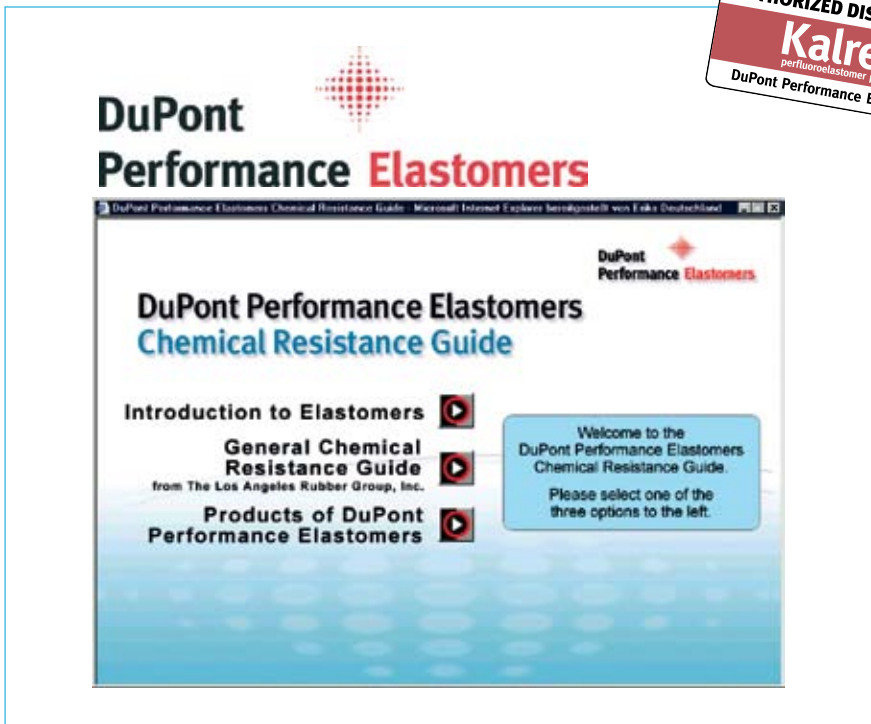
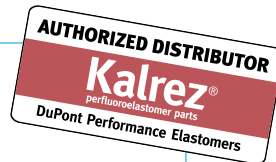



### 6. Compound Selection - Kalrez®

#### Kalrez® for extreme service – engineered for optimum performance

Whenever seals or rubber components are exposed to aggressive chemicals or high temperature, Kalrez® perfluoroelastomer parts outlast the alternatives. Only Kalrez® parts can match the virtually universal chemical resistance and high-temperature stability of PTFE while adding the resilient, no-creep properties of a true rubber.

For over 30 years, DuPont and DuPont Performance Elastomers have been relentless in pursuing improvement in the manufacture of perfluoroelastomer parts. Elastomeric parts typically consist of three components: a polymer chain (the backbone of the elastomer), a crosslinking system (which links the polymer chains together and is the key to elasticity and sealing performance), and a filler system (used to enhance mechanical properties). Based on their extensive experience, DuPont Performance Elastomers adjusts these components to optimize seal performance.

#### Increase safety

Lasting longer and performing better than other elastomers, Kalrez® helps reduce the risk of chemical exposure from seal failure.

#### Increase productivity

By reducing the frequency of seal changes, repairs and inspections, you can increase process and equipment uptime for greater productivity and yield.

#### Reduce maintenance costs

Kalrez® parts help stretch your mean time between repair (MTBR) and lower your maintenance costs. Their durability minimizes unscheduled downtime while letting you extend time between routine inspections and replacement cycles for critical components.

#### Superior chemical resistance to more than 1800 chemicals

Kalrez® perfluoroelastomer parts have virtually universal chemical resistance. They withstand attack from more than 1800 chemicals, solvents and plasmas. Standardizing on Kalrez® products for broad chemical resistance reduces your need to keep multiple materials on the shelf, thus lowering cost of inventory.

#### Service temperature range up to 327°C

Even after long-term exposure to temperatures up to 327°C (620°F), Kalrez® retains its elasticity and recovery properties better than other high-temperature elastomers. Its high-temperature properties, coupled with near universal chemical resistance, enable Kalrez® parts to withstand an extremely broad range of process media.

#### Maintains sealing force to keep seals tight

As proven in ISO 3384 tests, Kalrez® outperforms other elastomers when it comes to sealing force retention, a measure of seal life. Even under harsh and aggressive conditions, Kalrez® will retain its sealing force longer. And thanks to its true-rubber resiliency, Kalrez® prevents leaks caused by creep, a major problem with PTFE.



#### Field Proven

- Over 3 years in Dowtherm\* A at 246°C (475°F)
- Over 24 months in sour gas (9% H<sub>2</sub>S, 15-19% CO<sub>2</sub>) at 149°C (300°F)
- Over 1 month in silicon water nitride process with chlorine and ammonia gas at 218°C (425°F)
- Over 1 year in O-nitrochlorobenzene at 220°C (428°F)
- Over 1 year in maleic anhydride at 169°C (335°F)
- Over 6 months in hot asphalt at 316°C (600°F)
- Over 4 months in 70% acetic acid at 220°C (428°F)
- Over 1 year in dry steam at 250°C (482°F)
- 3 months with lowest ppb ionic extractable levels in wet semiconductor process chemicals at 100°C (214°F)
- Over 17 months in hydrocarbons at 288°C (550°F)
- Over 1 year in N-methyl-2-pyrrolidone at 232°C (450°F)

\*Registered trademark of The Dow Chemical Company



Kalrez® and Kalrez® Spectrum™ are registered trademarks or trademarks from DuPont Performance Elastomers.

### 6. Compound Selection - Kalrez®

#### Kalrez®: Durable, safe seals in virtually any environment

Because of the unique chemical structure of the material, Kalrez® parts can provide the most durable seals at temperatures up to 326°C/620°F in virtually any chemical media. No other seal, including other perfluoroelastomers, can perform for such extended periods in such aggressive environments. Kalrez® parts provide an effective (and cost effective) solution in a variety of industries.

1. In chemical processing and petroleum refining, O-rings are used in mechanical seals, pump housings, reactors, mixers, compressor casings, valves, rotameters, and other equipment. Custom-designed parts are used as valve seats, packings, diaphragms, gaskets, and U-cups. Kalrez® parts can be specified as standard seals for most mechanical seal types.

2. In analytical and process instruments, septa, O-rings, diaphragms, valve seats, column fittings, ferrules, and gaskets, Kalrez® solves tough chemical sealing problems. They also provide exceptional outgassing resistance under high vacuum at temperatures 100°C / 232°F above the limits of other elastomers.

3. In chemical transportation, O-rings and other seals are used in safety relief and unloading valves to prevent leakage from tank trucks and trailers, rail cars, ships and barges carrying hazardous and corrosive chemicals. Compliance with new government restrictions can be easier with Kalrez® parts.

4. In semiconductor manufacturing operations, O-rings and other parts are utilized to seal aggressive chemical reagents and specialty gases required for processing silicon chips. Also, the combination of thermal stability and low outgassing characteristics are desirable in furnaces for growing crystals and in high vacuum applications.

5. In energy production, V-ring packer seals, O-rings, T-seals, and custom parts are used in sour gas and oil wells at pressure differentials up to 138MPa (20.000 psi) and temperatures of 232°C. Specialty electrical connector boots are used in logging equipment for gas, oil, and geothermal steam wells at temperatures up to 307°C / 575°F.

6. In aircraft and aerospace industries, lip seals, diaphragms, O-rings, and custom designed parts are used on aircraft engines and rocket propellant systems. Because of their excellent thermal stability and resistance to aero-lubricants fuels, hydraulic media, hydrazine, oxidizers such as dinitrogen tetroxide, and other aggressive fluids, Kalrez® parts are especially suited for a number of demanding applications.

**On the following pages, ERIKS presents the next generation of Kalrez® compounds from DuPont Performance Elastomers.**



### 6. Compound Selection - Kalrez®

#### Kalrez® Spectrum™ - long-term service and exceptional value in use

Chemical and hydrocarbon processors must contain some of the most hazardous materials used in manufacturing. Kalrez® Spectrum™ perfluoroelastomer parts were designed to reliably seal in the most demanding environments.

For applications where there are mixed streams, unknowns in the process, or process excursions, Kalrez® Spectrum™ 6375 provides the broadest chemical resistance. Kalrez® Spectrum™ 6375 withstands aggressive chemical families including acids, amines, bases, aldehydes, ethylene oxide, and hot water/steam. Such broad chemical resistance makes 6375 the preferred sealing material across many applications which will allow for seal standardization and lower part inventory.

For many years Kalrez® 4079 was the standard for difficult sealing applications. Today Kalrez® Spectrum™ 7075 offers an improved level of chemical resistance over 4079. Although Kalrez® Spectrum™ 6375 is the best choice for most applications requiring chemical resistance, 7075 is the choice for service at elevated temperatures.

#### Thermal resistance compatible with application requirements

An elastomer's thermal stability and chemical resistance are usually the first performance characteristics considered when determining elastomeric seal compatibility. Kalrez® Spectrum™ 6375 and 7075 provide end-users options based on specification requirements. Because the majority of the chemical and hydrocarbon processing environments operate below 260°C, Kalrez® Spectrum™ 6375 is a safe and economical choice for applications in a variety of harsh environments.

With an operating temperature up to 275°C and broad chemical resistance, 6375 provides reliable sealing in a variety of environments to allow for seal standardization and lower inventory.

For operating conditions above 275°C, Kalrez® Spectrum™ 7075 is the choice over Kalrez® Spectrum™ 6375. Kalrez® 4079 has been the product of choice in higher temperature applications for many years. Now 7075 provides better thermal resistance, compression set and sealing force retention, as well as an overall improvement in chemical resistance. This combination of properties makes it an excellent choice for applications in high temperatures or temperature cycling conditions that require good dynamic properties and excellent compression set.

#### Kalrez® Spectrum™ 6375 - Broad chemical resistance Kalrez® Spectrum™ 7075 - Thermal resistance

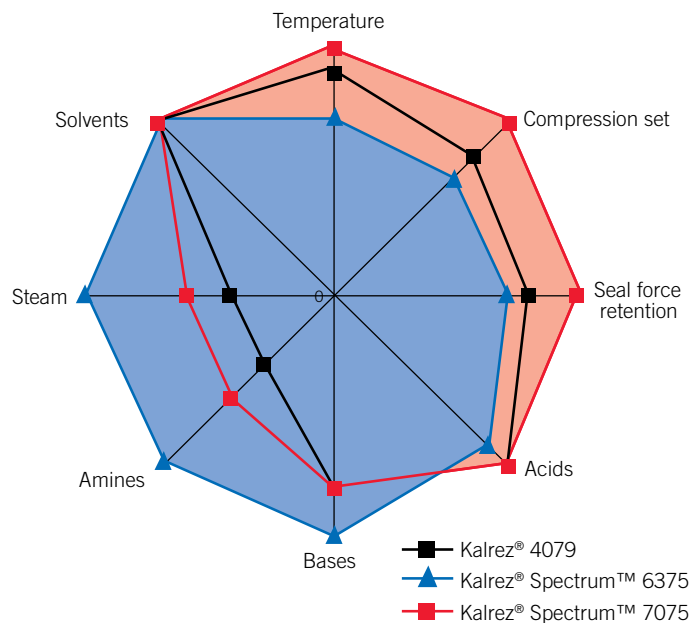

Table 2 - Chemical resistance

Chemical Resistance to:	Kalrez® Spectrum 7075	Kalrez® 4079	Kalrez® 6375
Aromatic/Aliphatic oils	++++	++++	++++
Acids	++++	++++	++++
Bases	+++	+++	++++
Alcohols	++++	++++	++++
Aldehydes	++++	+++	+++
Amines	++	+	++++
Ethers	++++	++++	++++
Esters	++++	++++	++++
Ketones	++++	++++	++++
Steam/Hot Water	++	+	++++
Strong Oxidizers	++	++	++
Ethylene Oxide	+++	x	++++
Hot air	++++	++++	+++

++++ = Excellent, +++ = Very good, ++ = Good, + = Fair, x = Not recommended.

### 6. Compound Selection - Kalrez®

#### Kalrez® Spectrum™ 6375

Kalrez® Spectrum™ 6375, designed specifically for the chemical process industry, combines new polymer technology with innovative patented curing technology. Compound 6375 is designed to give outstanding performance in the widest possible range of chemicals and temperatures.

This product is an excellent choice for use in acids, bases, amines, steam, ethylene oxide, and many other aggressive chemicals. Mixed streams, once a problem for many chemical processors, can now be handled by compound 6375. The new curing system also allows for a continuous upper service temperature of 275°C (525°F). This is approximately 40°C (100°F) higher than other products claiming broad chemical resistance. This high temperature stability translates to increased chemical resistance over all temperature ranges, especially if high temperature process excursions occur. This combination of chemical and thermal resistance provides advantages for chemical processors.

Today, chemical processors use several perfluoroelastomer parts, including compounds 4079, 1050LF, and 2035, to optimize chemical and thermal performance. Kalrez® Spectrum™ 6375 may be used in many applications to displace these products. However, if optimum chemical resistance is required, then applications must be individually reviewed for the optimum compound selection.

#### Typical Physical Properties

	6375	7075
Hardness, Shore A	75	75
100% Modulus <sup>2</sup>	7,2 MPa	7,58 MPa
Tensile Strength At Break	15,1 MPa	17,91 MPa
Elongation At Break	160%	160%
Compression Set <sup>3</sup> , 70h/204°C	30%	15%
Maximum Service Temperature	275°C (525°F)	327°C (620°F)

<sup>2</sup> ASTM D 412

<sup>3</sup> ASTM D 395 B, O-rings

#### Kalrez® Spectrum™ 7075

Kalrez® Spectrum™ 7075 joins the family of Kalrez® Spectrum™ products designed for the chemical processing industry. Compound 7075 broadens the family of Spectrum™ sealing options with enhanced physical performance properties including very low compression set and improved seal force retention. Kalrez® 7075 o-rings have a glossy finish for dynamic applications that may benefit from less drag.

Kalrez® Spectrum™ 7075 is designed for general-purpose use as o-rings or custom sealing components in the chemical and hydrocarbon processing industries. It is a carbon black-filled compound with mechanical properties designed for improved sealing performance in temperature cycling applications. 7075 has improved thermal resistance that extends maximum service temperature to 327°C (620 °F). It is not suggested for use in severe aqueous and amine applications where Kalrez® Spectrum™ 6375 remains the preferred compound. As always, we recommend the specific chemicals, service temperature and pressure be reviewed for the optimal compound selection in each application.

Kalrez® Spectrum™ 7075 offers very low compression set as measured by ASTM D395 to predict heat resistance. DuPont Performance Elastomers compression set testing extends the standard ASTM 70 hour protocol to include 336 and 672-hour compression set testing, which better predicts long-term o-ring performance. Less compression set results in improved sealing and longer service life.

Kalrez® Spectrum™ 7075 also offers approximately 10% higher seal force retention than Kalrez® 4079, as measured under the conditions of ISO 3384 (Figure 2). Higher seal force retention equates to better elastomeric properties at service temperature and pressure, resulting in more reliable, long-term seal performance.

### 6. Compound Selection - Kalrez®

#### Kalrez® Spectrum™ 7090

Kalrez® Spectrum™ 7090 - the latest addition to the Kalrez® Spectrum™ family of products - is targeted for static and dynamic sealing in applications requiring high hardness, higher modulus, and extrusion resistance at continuous service temperatures as high as 325°C.

Kalrez® Spectrum™ 7090 offers users an impressive combination of mechanical properties, including:

- outstanding compression set resistance and seal force retention,
- excellent response to temperature cycling effects,
- high resistance to rapid gas decompression,
- outstanding thermal stability and chemical resistance,
- lower coefficient of thermal expansion than other Kalrez® parts - minimizing need to increase free volume of seal gland when upgrading from FKM to FFKM.



#### Typical Physical Properties 7090

Hardness, Shore A	90
50% Modulus <sup>2</sup>	15,5 MPa
Tensile Strength At Break	22,75 MPa
Compression Set <sup>3</sup> , 70h/204°C	12%
Maximum Service Temperature	325°C (617°F)

<sup>2</sup> ASTM D 1414 & D 412 (AS568 K214 O-ring test specimen)

<sup>3</sup> ASTM D 1414 & D 395B (AS568 K214 O-ring test specimen)

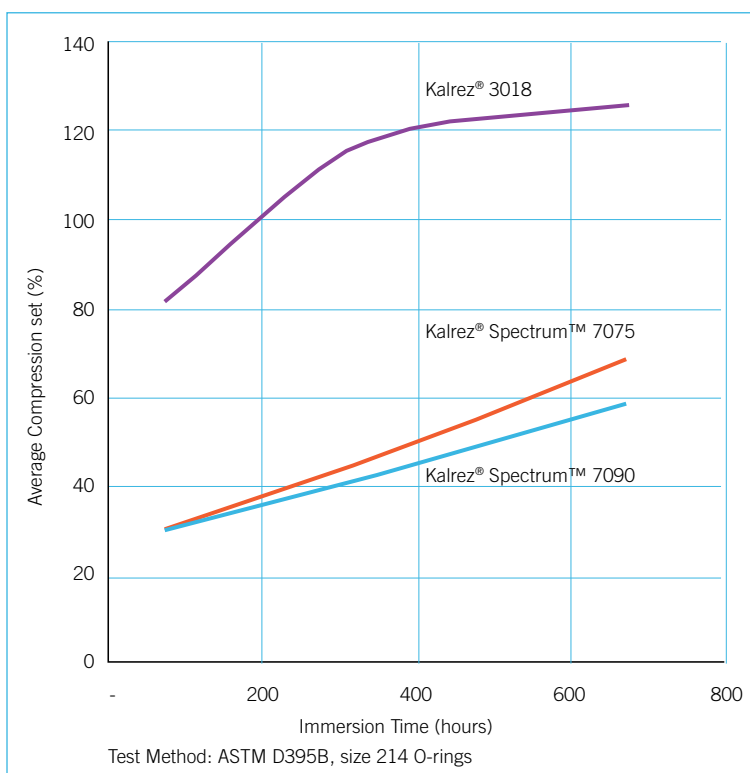

### 6. Compound Selection - Kalrez®



#### FAQs about Kalrez® Spectrum™

##### How are Kalrez® Spectrum™ products different from other Kalrez® products?

Kalrez® Spectrum™ perfluoroelastomer parts were designed to provide the best value and performance to meet the demands of the chemical and hydrocarbon processing industries (CPI/HPI) for broader chemical resistance, higher thermal resistance and better sealing force.

##### Which Kalrez® Spectrum™ product is best to use when my process has multiple chemical streams?

Kalrez® Spectrum™ 6375 has the broadest chemical resistance and is, therefore, more suitable for processes with multiple chemical streams or even unknown chemical streams. And, even if the process requires hot water flushes or steam cleaning, Kalrez® Spectrum™ 6375 will most likely handle the job.

##### What is best to use in my temperature-cycling process?

Kalrez® Spectrum™ 7075 has the highest thermal resistance and sealing force retention, which makes it suitable for processes which elevate in temperature for a period of time and then return to lower process temperatures, while retaining its resilient properties.

##### How economical are the Kalrez® Spectrum™ products?

Kalrez® Spectrum™ 6375 is more economical than other Kalrez® products. Additional savings may be obtained if you standardize on Kalrez® Spectrum™ 6375 to handle all your existing applications versus carrying multiple types in inventory. Kalrez® Spectrum™ 7075 should have comparable economics to Kalrez® products you have used in the past.

##### Is Kalrez® 4079 being phased out?

Absolutely not! Kalrez® 4079 has been the industry standard for over 20 years and is specified in many applications where it demonstrates outstanding performance. We will continue to make and supply our current products that meet the value and performance requirements of our many loyal customers and end users. In addition to our current product line, we will continue to develop the Kalrez® Spectrum™ line of products to meet the ever increasing requirements of the chemical and hydrocarbon industries.

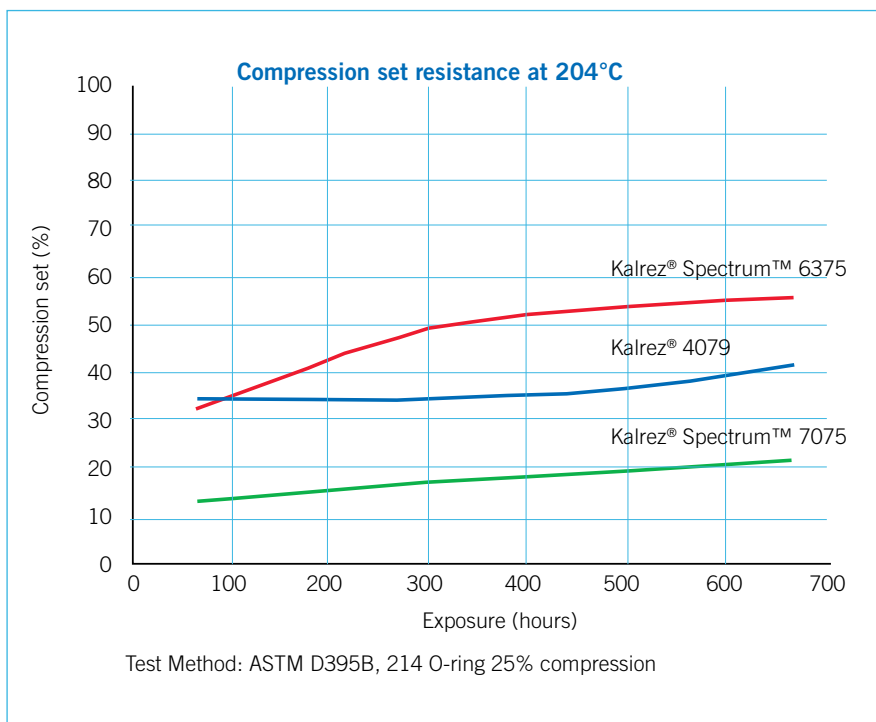

### 6. Compound Selection - Kalrez®



**Table 3 - Resistance to volume swell of Kalrez® Spectrum™ 6375 (1)**

Chemical	Temperature °C (°F)	Kalrez® Spectrum™ 6375	Nearest Competitive FFKM
Water	225 (437)	A	C
Glacial acetic acid	100 (212)	A	A
Nitric acid (70%)	85 (185)	B	C
Sulfuric acid (98%)	150 (302)	A	C
Ammonium hydroxide	100 (212)	B	B
Ethylene oxide	50 (122)	A	A
Epichlorohydrin	100 (212)	A	A
Butyraldehyde	70 (158)	A	B
Toluene diisocyanate	100 (212)	A	B
HCFC 134a	25 (77)	A	A

(1) Exposure time = 672 hours.

A = 1-10% volume swell, B = 10-20% volume swell, C = > 20% volume swell.

#### Kalrez® Spectrum™ 6375 combines low volume swell with good physical properties retention.

Low volume swell is critical to sealing performance in many applications. The result of lab testing to determine volume swell of Kalrez® Spectrum™ 6375 when exposed to some of the most aggressive fluids in the industry are shown here:

**Graph. 1**  
Volume change in ethylene oxide at 50°C, size 214 O-rings, ASTM D471

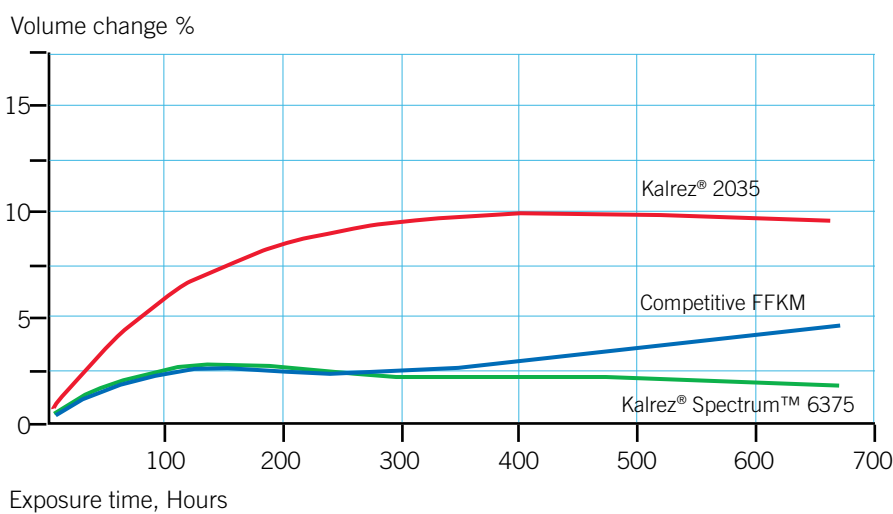



## 6. Compound Selection - Kalrez®



**Graph. 2**  
Volume change in 98% sulfuric acid at 150°C, size 214 O-rings, ASTM D471

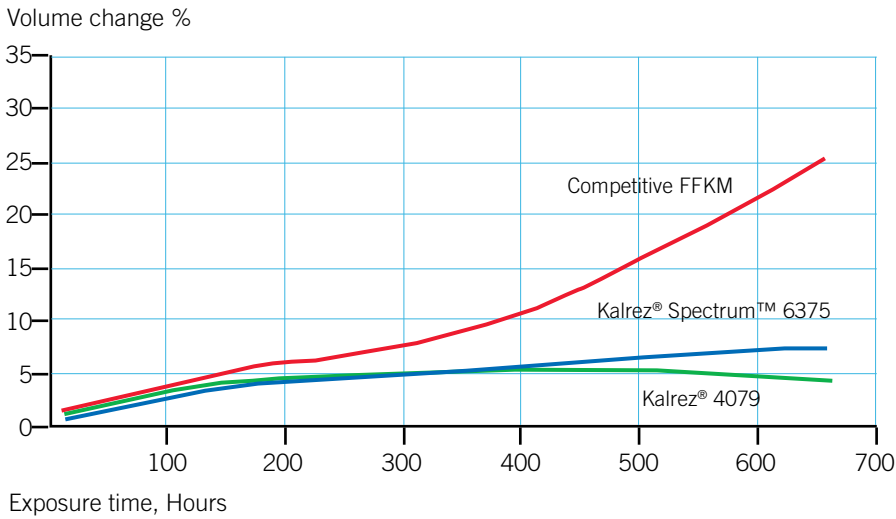

**Graph. 3**  
Volume change in toluene diisocyanate at 100°C, size 214 O-rings, ASTM D471

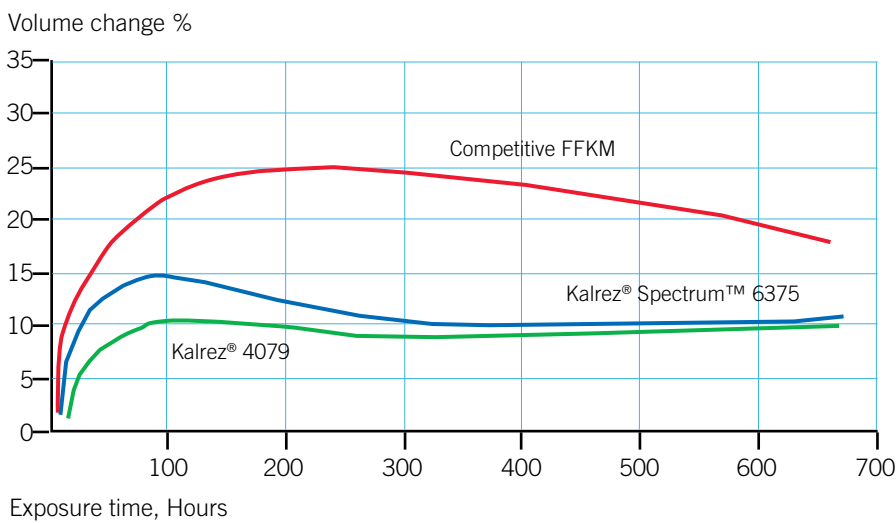

## 6. Compound Selection - Kalrez®



**Graph. 4 - Volume change in water at 225°C, size 214 O-rings, ASTM D471**

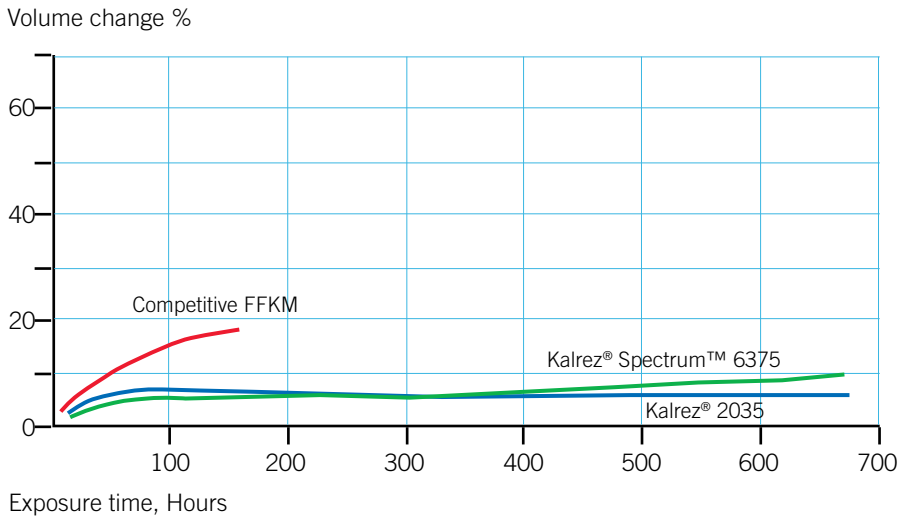

**Graph. 5 - Compression set at 240°C, size 214 O-rings, ASTM D471**

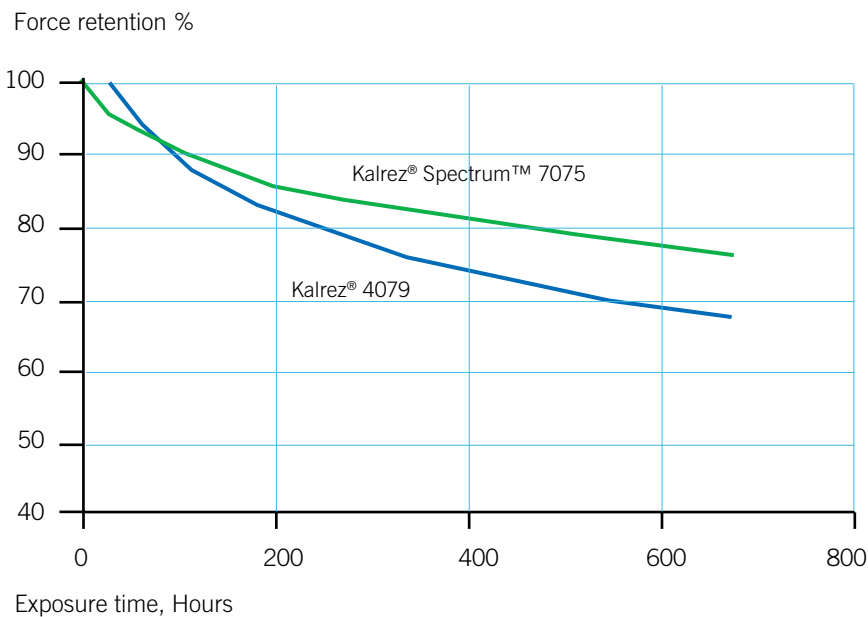

### 6. Compound Selection - Kalrez® in Semicon Industry

Chemical resistance that is nearly universal, coupled with superior high temperature properties, enables Kalrez® parts to withstand virtually any process media - including plasma - at temperatures up to 327°C (620°F).

By selecting the Kalrez® compound that is best suited to a specific application, processors can improve seal performance in all wafer fabricating operations, including thermal, gas/vacuum, dry plasma, and wet chemical systems.

#### **Kalrez® gives long-term sealing performance at high temperatures**

Kalrez® perfluoroelastomer parts retain elastic recovery properties and sealing force far better than other heat resistant elastomers - even after long term exposure at temperatures as high as 327°C (620°F). This thermal relaxation/stress aging test is a direct indication of long-term sealing effectiveness at elevated temperatures.

#### **Kalrez® Spectrum™ 7075 offers new high temperature performance standard for the CPI industry**

DuPont Performance Elastomers has unveiled Kalrez® Spectrum™ 7075, the first Kalrez® Spectrum™ product line expansion designed specifically for high temperature resistance in the chemical processing industry.

Customers have already reported exceptional seal performance in preliminary product testing, especially in mechanical seal applications.

Kalrez® Spectrum™ 7075 builds on the exceptional performance of Kalrez® 4079. By choosing 7075, customers will benefit from even longer seal life and increased mean time between repairs as a result of:

- Very low compression set at 204°C for 70 hours (15 %)
- Enhanced sealing force retention.
- Higher thermal resistance, up to 327°C / 620°F.

In addition 7075 offers broader chemical resistance and better cool down set recovery than Kalrez® 4079, and provides a smoother, glossier finish than other Kalrez® products.



#### **Kalrez® 9100 – The New ‘Workhorse’ For Deposition Applications**

The new Kalrez® 9100 exhibits ultra low particle generation and combines the best features of existing Kalrez® compounds for the semicon industry.

Kalrez® 9100 is an amber translucent product targeted specifically for deposition process applications, i.e., HDPCVD, PECVD, SACVD, Metal CVD, ALD, etc. It has also exhibited excellent performance in “select” etching and ashing/stripping process applications. Kalrez® 9100 has been specifically designed for low erosion and ultra-low particle generation in harsh plasma environments. It offers outstanding thermal stability, very low outgassing as well as excellent elastic recovery and mechanical strength properties and is well suited for both static and dynamic sealing applications. A maximum continuous service temperature of 300°C is suggested. Ultrapure post-cleaning and packaging is standard for all parts made from Kalrez® 9100.

Kalrez® 9100 has been reported to significantly improve wafer production in a variety of semiconductor process applications, i.e., HDPCVD, PECVD, etching, ashing, etc., where oxygen and fluorinated plasmas are used during the cleaning cycle. In a number of evaluations at fab line customers, Kalrez® 9100 exhibited less erosion, lower particle generation and longer seal life compared to competitive perfluoroelastomers in both static and dynamic sealing applications.

#### **Kalrez® Application Guide**

The Kalrez® Application Guide is ready to be downloaded from the internet in the always up-to-date version.

The easy guide to choosing the best perfluoroelastomer seal for an application now includes the latest chemical processing and semi-conductor compounds from Kalrez®. It helps in compound selection by rating the resistance of Kalrez® compounds to virtually any combination of temperature and chemical media, and it helps you in seal design.

The seal design selection will assist in designing a groove for a specific O-ring, and calculate seal performance parameters in various temperature and swell conditions at minimum and maximum O-ring groove tolerance.

**Download NOW at: [www.dupontelastomers.com](http://www.dupontelastomers.com)**

### 6. Compound Selection - Kalrez® in Semicon Industry

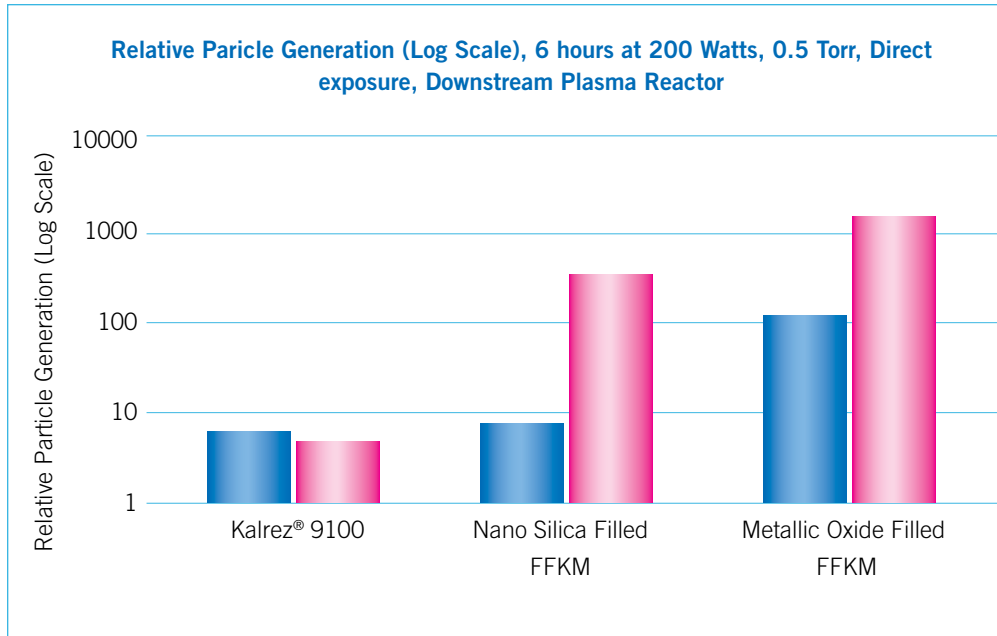

#### Kalrez® for specific semicon processes

Semicon Process	Suggested Compound
Plasma	<p>9100 - Optimum for deposition process applications. Low erosion rate and ultra-low particle generation in oxygen and fluorine-based plasmas. Excellent elastic recovery properties.</p> <p>Alternatively:</p> <p>8085 - General purpose product for all plasma processes. Excellent mechanical strength properties.</p> <p>8002 - Transparent product for “select” plasma process applications. Ultra-low particle generation in oxygen and fluorine-based plasmas.</p>
Thermal	<p>7075UP - Optimum for LPCVD, ALD, oxidation and diffusion thermal process applications.</p> <p>8475 - Optimum for lamp anneal and RTP thermal process applications.</p>
Wet	<p>6375UP - Optimum for wet process applications.</p> <p>Alternatively:</p> <p>4079 - Excellent chemical resistance.</p> <p>1050LF - Excellent amine resistance.</p>

### 6. Compound Selection - Kalrez® in Semicon Industry

#### Suggested Products for Semiconductor Use

**Kalrez® 9100** is an amber translucent product targeted specifically for deposition process applications, i.e., HDPCVD, PECVD, SACVD, Metal CVD, ALD, etc. It has also exhibited excellent performance in “select” etching and ashing/stripping process applications. Kalrez® 9100 has been specifically designed for low erosion and ultra-low particle generation in harsh plasma environments. It offers outstanding thermal stability and very low outgassing as well as excellent elastic recovery and mechanical strength properties and is well suited for both static and dynamic sealing applications (e.g., gas inlet seals, gas orifice seals, chamber lid seals, isolation valve seals, bonded gate valve/slit valve door seals, etc.). A maximum continuous service temperature of 300°C is suggested.

**Kalrez® Sahara™ 8085** is a beige, general purpose product for all plasma process applications, i.e., etching, ashing/stripping, HDPCVD, PECVD, SACVD, etc. It has been formulated for minimal particle generation in NF3 plasma. Kalrez® Sahara™ 8085 exhibits very low particle generation and low weight loss in oxygen and fluorine-based plasma, has excellent mechanical properties and is well-suited for both static and dynamic sealing applications (e.g., bonded slit valve doors, bonded gate valves, bonded pendulum valves, gas orifice seals, gas inlets, gas feedthrough seals, chamber lid seals, etc.). A maximum continuous service temperature of 240°C is suggested. Kalrez® Sahara™ 8085 can also withstand short-term excursions up to 275°C.

**Kalrez® 8002** is a clear, transparent product targeted specifically for “select” plasma process applications, i.e., etching, ashing/stripping, deposition etc. This unfilled product offers ultra-low particle generation in oxygen and fluorine-based plasmas versus mineral-filled products. Kalrez® 8002 exhibits excellent resistance to dry process chemicals, has good mechanical properties and is well suited for static, low stress/low sealing force and “select” bonded door seal applications. A maximum continuous service temperature of 275°C is suggested.

**Kalrez® 7075UP** is a black product targeted specifically for semiconductor oxidation, diffusion furnace and LPCVD thermal process applications. It offers outstanding thermal stability, very low outgassing and excellent compression set properties. Kalrez® 7075UP exhibits excellent seal force retention, has good mechanical properties and is well suited for both static and dynamic sealing applications. A maximum continuous service temperature of 327°C is suggested. Short excursions to higher temperatures may also be possible.

**Kalrez® Sahara™ 8475** has been specifically developed to meet the challenging requirements associated with sealing applications in semiconductor thermal processes (i.e., oxidation, diffusion furnace, LPCVD, RTP, lamp anneal, etc.). It exhibits excellent thermal stability and long-term sealing performance, less IR absorption and significantly reduced outgassing properties at elevated temperatures. Kalrez® Sahara™ 8475 has good mechanical properties and is well-suited for static and low stress/low sealing force applications (e.g., quartz tube seals, ball joint seals, bell jar seals, plenum seals, etc.). A maximum continuous service temperature of 300°C is suggested.

**Kalrez® 6375UP** is a black product for semiconductor wet process applications. This product exhibits excellent chemical resistance to all different types of wet process chemicals including acids, bases and amine-base strippers. It features low elemental extractables with good mechanical and compression set properties and is well-suited for both static and dynamic wet process seal applications (e.g., filter seals, drain seals, flowmeters). A maximum continuous service temperature of 275°C is suggested.

More Kalrez® compounds for use in select semicon applications available.

Ultrapure post-cleaning and packaging is standard for parts made from Kalrez® 9100, Sahara™ 8085, 8002, 7075UP, Sahara™ 8475 and 6375UP.



### 6. Compound Selection - specials



#### Kalrez® Compounds

Kalrez® Compound	Hardness (Shore A)	Tensile Strength (MPa)	Compression Set (%)*	Max. Service Temp. (°C/°F)	Colour	Segment	Application
Spectrum 6375	75	15,16	25	275 / 527	Black	CPI	Broadest chem. resistance
Spectrum 7075	75	17,91	12	327 / 620	Black	CPI	High temp., temp. cycles
4079	75	16,88	25	316 / 600	Black	CPI	General
1050LF	82	18,6	35	288 / 550	Black	CPI	General, steam, amines
1058	65	8,96	40	260 / 500	Black	CPI	Applications require low sealing force
3018	91	21,7	35	288 / 550	Black	CPI	High pressure, steam
2037	79	16,88	27	220 / 428	White	CPI	Oxidizing environment
6221	70	15,16	31	260 / 500	White	Pharma/Food	FDA, USP
6230	75	16,54	30	260 / 500	Black	Pharma/Food	FDA, USP
9100	74***	11,85	17**	300 / 572	Amber translucent	Semicon	Deposition processes
8085	80	16,3	42**	240 / 464	Beige	Semicon	Plasma
8002	69	15,95	15**	275 / 527	Clear translucent	Semicon	Selected plasma
Spectrum 7075UP	75	17,91	15	327 / 620	Black	Semicon	Thermal
8475	60	11,35	23**	300 / 572	White	Semicon	Thermal
Spectrum 6375UP	75	15,16	25	275 / 527	Black	Semicon	Wet
8575	62		29	300 / 527	White	Semicon	Selected etching, ashing stripping and deposition
4079	75	16,88	25	316 / 600	Black	Semicon	Wet
2037	79	16,88	27	220 / 428	White	Semicon	Selected plasma and gas deposition
1050LF	82	18,6	35	288 / 550	Black	Semicon	Selected wet with high amine content
Spectrum 7090	90	22,75	12	325/617	black	CPI	High pressure, high temperature

In collaboration with DuPont Performance Elastomers ERIKS offers an FEA analysis of sealing applications to aid in the correct selection of Kalrez® O-ring compounds.

\*acc. to ASTM D 395B (pellet test specimen unless otherwise noted)

\*\*acc. to ASTM D 395B and ASTM D 1414 (AS568A K214 O-ring test specimens)

\*\*\*Shore M acc. to ASTM D 2240 and ASTM D 1415 (AS568A K214 O-ring test specimens)

### 6. Compound Selection - Encapsulated Teflex

#### 1. Why are Teflex O-Rings needed?

There are certain applications which prohibit the use of conventional rubber O-Ring seals. The use of hostile chemicals or extreme temperatures (both high and low) during various processes can make effective sealing very difficult. Many seal manufacturers have produced different "high performance" materials for these applications. ERIKS has contributed to this area by introducing Teflex. The following is the summary of these "high performance" products compared with Teflex.

#### Solid PTFE

Solid PTFE O-Rings enjoy true chemical inertness. This is the only advantage over Teflex. PTFE suffers badly from cold flow and has little memory to return to its original form.



#### PTFE enveloped

Enveloped O-Rings too enjoy true chemical inertness and are low in cost to produce. The design of the PTFE envelope may allow the chemical to reach and attack the core material resulting in premature failure.



#### PTFE coated

O-Rings coated with suspended PTFE dispersion give some low friction properties but the coating is easily removed. This method of manufacture is low in cost but offers practically no chemical protection.



#### Perfluoroelastomer

A Perfluoroelastomer is the most technically advanced O-Ring material for corrosive applications. O-Rings made from Perfluoro offer very easy installation properties and display conventional elastomer characteristics.



#### Metallic (Tubular)

Tubular metallic O-Rings offer very good chemical resistance, high pressure ability, and flexible temperature ranges. They do however require very precise housing and surface finish detail and again can be quite expensive to produce.



There are certain applications for which we would not recommend the use of Teflex.

- Dynamic use where high speeds and poor surface finishes are encountered.
- Where the housing design requires excessive stretch. Teflex is very difficult to stretch.
- When the media in contact with the O-Ring has an abrasive nature, sand, slurry, etc..

#### 2. Introduction to Teflex

A Teflex O-Ring comprises an elastomeric energising core, which has a seamless jacket made from a fluoropolymer.

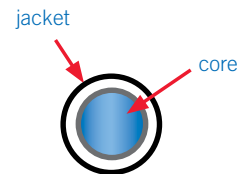

The elastomeric core may be Viton® or Silicone. The jacket is made from Teflon® FEP or PFA.

10 years of experience with these O-Rings indicate this product is a perfect sealing solution for typical applications. ERIKS' world-wide experience with thousands of applications ensures that Teflex is a quality product.





### 6. Compound Selection - Encapsulated Teflex

#### 3. Material specifications

FEP is a copolymer of hexafluoropropylene and TFE.  
 PFA is also a copolymer of TFE but with perfluorinated ether.  
 ERIKS Viton® compound has been designed specifically to give optimum compression set characteristics.  
 This feature is paramount in the cores function of energising the Teflon jacket and aiding its recovery from compression.

#### ERIKS Viton® compound meets the following specifications:

Hardness:	ASTM D 2240	75° ± 5° Shore 'A'
Tensile strength:	ASTM D 412	min. 10.7 MPa
Elongation:	ASTM D 412	min. 213%
Specific weight:	ASTM D 1817	2.32 ± 0.04
Compression set:	ASTM D 395B	
on slab		4.6% (175°C)
on O-Ring 5mm		< 10% (200°C)

#### Heat ageing **ASTM D 573**

Hardness	+3°
Tensile strength	+15%
Elongation change	-29%

#### ERIKS silicone compound meets the following specification:

Hardness:	ASTM D 2240	min. 70 ± 5° Shore 'A'
Tensile strength:	ASTM D 412	min. 8.6 MPa
Elongation:	ASTM D 412	min. 280%
Specific weight:	ASTM D 1817	1.26
Compression set:	ASTM D 395B	
22h/175°		< 32%

Silicone is FDA compliant.



#### 5. Installation

The correct installation of Teflex O-Rings is essential for prolonged seal life. A very large percentage of seal problems are caused by incorrect fitting procedures.

To fit a Teflex O-Ring into an internal bore type housing the seal needs to be collapsed. This is best achieved by immersing the seal in hot water (60°-80°C) prior to fitting which gives much greater flexibility to the jacket. Take the seals out of the water one at a time and quickly slide the seal into the bore passing the leading edge over and past the groove. It is important that the groove is chamfered and free from burrs or damage will be caused to the jacket. After the trailing edge of the seal is located into the groove, the leading edge has to be pulled backwards taking care to apply even pressure around the circumference of the seal to avoid kinking of the jacket.

Snap the O-Ring into the groove and smooth out evenly. It may be wise to insert the shaft before the O-Ring cools down. It is important that the surface finish should not exceed 20 microinch.

#### 4. Markets and applications

There is hardly a market in which Teflex O-Rings are not currently utilised and they are very well established in the following industries: chemical processing and production, oil extraction, petrochemical refining, pharmaceutical production, food and drink processing, paint and die manufacture, refrigeration engineering, cosmetics and perfumery, automotive components, and aerospace engineering.

Mechanical seals

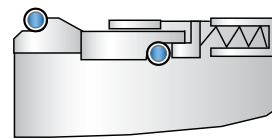

Filter elements

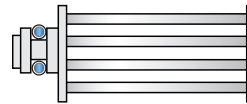

Mixers and vessels

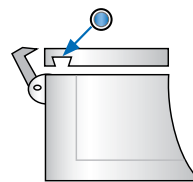

Heat exchangers

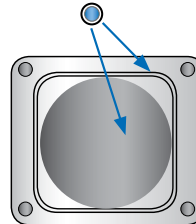

Valves

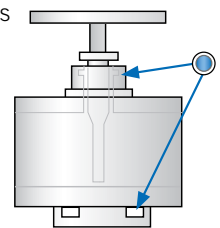

Pumps

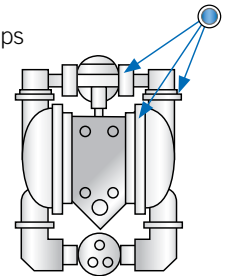

Flanges

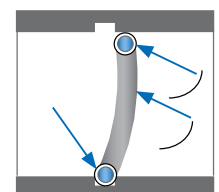
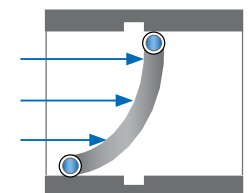
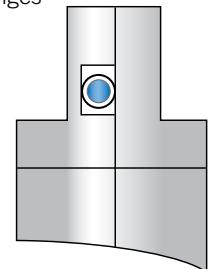

### 6. Compound Selection - Encapsulated Teflex

#### 6. Availability

The following are examples of such formats but we would consider any requests for special items not displayed here.

#### Circular

Circular shapes are by far the most common and account for over ninety percent of the current production. Available as small as 5 mm inside diameter with no upper diameter limit.

#### Oval

Oval shapes are used mainly in "inspection hatch" applications on chemical vessels. ERIKS can produce most of the common hatch sizes as well as non standards.

#### Semi circular

Semi circular shapes are used for both inspection hatch and heat exchanger sealing. There are no standard sizes available but tooling costs are very low so most applications are worth serious consideration.

#### Square and rectangular

Square and rectangular shapes are used in many applications such as heat exchanger plate and pump housings. All the above shapes (excluding circular) have to be produced with radiused corners and are priced on application.

#### FEP Jacket on solid Viton® core



This the most popular combination and indeed the most technically capable in providing a compression seal. The Viton® core compound has been specifically formulated to give very low compression set results and this characteristic speeds up the somewhat slow memory of the FEP jacket. The temperature range is -20°C to +204°C / -20°F to +392°F.

#### FEP Jacket on solid Silicone core



This combination again is very popular and this is due to lower cost against that of the Viton® core. Technically it is inferior to Viton® except when used for low temperature use. The temperature range is -60°C to +204°C / -76°F to +392°F.

#### PFA Jacket on solid Viton® core



PFA offers higher abrasion resistance to that of FEP and the cost is approximately 50% higher. The temperature range is -20°C to +204°C / -4°F to +392°F.

#### PFA Jacket on solid Silicone core



This combination is preferred for higher temperature applications. The PFA jacket shares the same temperature service limits as the Silicone core.

The temperature range is -60°C to +260°C / -76°F to +500°F.

#### FEP Jacket on hollow Silicone core or hollow Viton® core



Used commonly where low seal loading is encountered. For slow reciprocating or rotary movement, the hollow core does not offer as much of an energising load thus reducing jacket wear and premature failure.

#### PFA Jacket on hollow Silicone core or hollow Viton® core



Used for the same applications as FEP on hollow Silicone core or hollow Viton® core but when additional abrasion resistance is necessary to prolong the seal life.

#### FEP Jacket on Solid Viton® or Silicone core



Rectangular and square sections can be produced and ERIKS has a standard range of gaskets in the price list section for cam action type hose couplings. These provide a far superior alternative to envelope gaskets or solid PTFE joints. The temperature range is -20°C to +204°C / -4°F to +392°F.

### 6. Compound Selection - Encapsulated Teflex

#### 7. Size range

Teflex O-Rings are manufactured according to standard sizes:

- Metric
- BS 1806
- BS 4518
- AS 568, AS 871
- JIS B2401
- and also as non-standards to customer requirement.

#### Size range

##### smallest inside Ø possible (in mm)

Cord (mm)	Viton® Core	Silicone Core	Silicone/Viton® Hollow Core
1,60	10,00	5,00	not possible
1,78	10,00	5,28	8,0
2,00	10,00	6,80	10,00
2,50	12,00	7,40	12,00
2,62	12,00	7,60	16,00
3,00	15,00	12,00	20,00
3,40	15,00	12,50	23,00
3,53	15,00	13,00	24,00
4,00	16,00	14,00	28,00
4,25	17,00	14,50	32,00
4,50	18,00	15,00	35,00
5,00	22,00	20,00	42,00
5,33	25,00	22,00	48,00
5,50	27,00	23,00	50,00
5,70	27,00	24,00	60,00
6,00	30,00	27,00	75,00
6,35	40,00	40,00	90,00
6,99	50,00	50,00	100,00
8,00	75,00	75,00	150,00
8,40	80,00	80,00	160,00
9,00	100,00	100,00	175,00
9,52	120,00	105,00	200,00
10,00	140,00	110,00	230,00
11,10	150,00	115,00	250,00
12,00	180,00	120,00	300,00
12,70	190,00	130,00	350,00

There is no upper limit to inside diameters. Please refer to the design and installation section for housing details.

It is not recommend to stretch O-Rings smaller than 12 mm inside diameter. This often results in breakage of the core which is not vulcanised on small sizes.

#### Thickness of the FEP/PFA jacket:

Following thickness are standard:

Ø section	Thickness FEP/PFA
from 1,78 mm	0,24 mm
from 2,62 mm	0,34 mm
from 3,53 mm	0,36 mm
from 5,34 mm	0,50 mm
from 6,99 mm	0,55 mm

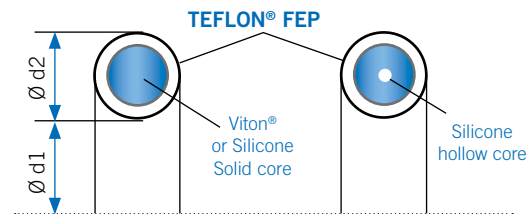

### 6. Compound Selection - Encapsulated Teflex

#### Cross Section Tolerances

The cross sectional tolerances for Teflex O-Rings differ to those achievable with moulded O Rings.

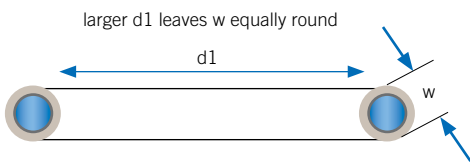

If an Teflex O-Ring is produced with a medium to large inside diameter (d1) the cross sectional diameter (w) remains reasonably round.

However, when Teflex O-Rings are produced with small inside diameters, the cross section (w) takes a degree of ovality. This is due to the memory of the jacket material and the result is that the axial height (a) may become greater than the radial width (r).

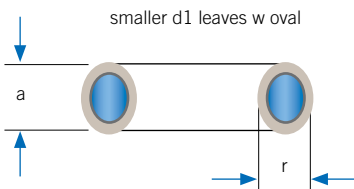

This cross section ovality means that a wider set of tolerances have to be applied to Teflex O-Rings as per the following chart.

Note however that hollow core rings cannot be produced as small as solid rings, see range of diameters applicable to hollow core in previous chart.

**Teflex® O-Ring Cross Section Tolerances**

Cross section tolerance depending on O-ring inner diameter			
(w)	d1 to d1	w±	d1 > w±
1.60	5.00 - 10.0	0.12	0.10
1.78	5.28 - 12.0	0.12	0.10
2.00	6.80 - 15.0	0.12	0.10
2.40	7.40 - 17.0	0.15	0.12
2.50	7.40 - 17.0	0.15	0.12
2.62	7.60 - 18.0	0.15	0.12
3.00	12.0 - 20.0	0.20	0.15
3.40	12.5 - 22.5	0.20	0.15
3.53	13.0 - 25.0	0.20	0.15
3.60	13.0 - 25.0	0.20	0.15
4.00	14.0 - 30.0	0.30	0.25
4.25	14.5 - 35.0	0.30	0.25
4.50	15.0 - 40.0	0.30	0.25
5.00	20.0 - 45.0	0.30	0.25
5.34	22.0 - 50.0	0.30	0.25
5.50	23.0 - 52.0	0.30	0.25
5.70	24.0 - 54.0	0.30	0.25
6.00	27.0 - 56.0	0.35	0.30
6.35	40.0 - 58.0	0.35	0.30
6.50	45.0 - 59.0	0.35	0.30
6.99	50.0 - 60.0	0.35	0.30
8.00	75.0 - 90.0	0.45	0.40
8.40	76.0 - 100.0	0.45	0.40
9.00	95.0 - 125.0	0.45	0.40
9.52	105.0 - 150.0	0.45	0.40
10.00	110.0 - 170.0	0.60	0.50
10.50	112.0 - 180.0	0.60	0.50
11.10	115.0 - 200.0	0.60	0.50
12.00	120.0 - 250.0	0.60	0.50
12.70	130.0 - 300.0	0.60	0.50
14.00	180.0 - 300.0	0.60	0.50
14.30	180.0 - 400.0	0.75	0.60
15.00	250.0 - 450.0	0.75	0.60
15.90	280.0 - 500.0	0.85	0.70
18.00	325.0 - 700.0	1.00	0.80
19.05	350.0 - 750.0	1.00	0.80
20.63	400.0 - 875.0	1.00	0.90
25.40	425.0 - 1000.0	1.25	0.90
30.00	475.0 - 1250.0	1.50	1.20
32.00	500.0 - 1500.0	1.75	1.50

### 6. Compound Selection - Encapsulated Teflex

#### Inside Diameter (d1) Tolerance

It is not possible to produce Teflex O-Rings to the same inside diameter tolerance as a moulded O-Ring.

Due to the temperature sensitivity of Teflon®, Teflex O-Rings are produced and controlled to conform with ISO 3302-1 M2F.

d1	tol
5.0mm thro 16.0mm	+/- 0.20
16.0mm thro 25.0mm	+/- 0.25
25.1mm thro 40.0mm	+/- 0.35
40.1mm thro 63.0mm	+/- 0.40
63.1mm thro 100.0mm	+/- 0.50
100.1mm thro 160.0mm	+/- 0.70
thereafter the tolerance will be of thenominal inside diameter of the ring	+/- 0.5%
example : inside diameter of 310.0mm	
tolerance = +/- 1.55mm (0.5%)	

#### 8. Chemical resistance

FEP and PFA Teflex O-Rings don't absorb most chemical until the temperature reaches 200°C. In the next diagram are the absorption figures at different temperatures:

Chemical product	Temp °C	Time	% Absorption
Aniline	185	168 h	0,3
Benzaldehyde	200	168 h	0,7
Tetrachloride	78	168 h	2,3
Freon 113	47	168 h	1,23
Nitrobenzene	210	168 h	0,8
Toluene	110	168 h	0,8
Sulfuric acid 50%	100	168 h	0,01
Phosphoric acid	100	168 h	0,01
Sulfuric acid 30%	70	1 year	0
Chlorid acid 20%	70	1 year	0
Aceton	70	168 h	0
Benzene	78	168 h	0,5

#### 9. Compressive load requirements

Designers may require information showing details of compressive load required for Teflex O-Rings. In order to provide this information, ERIKS conducted tests on each of the common cross sectional diameters within our range of products. Samples were taken from typical production batches and tested to 10,15, and 20% compression rates.

It is possible, using the following table, to obtain the total force required to effect a desired compression of a Teflex O-Ring, thus allowing accurate selection of sufficient mechanical loading.

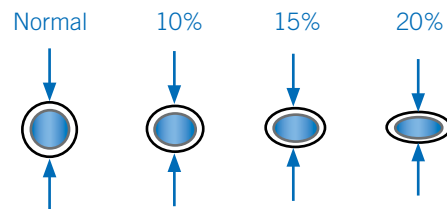

DIAM. mm	VITON® SOLID CORE Compression			SILICONE SOLID CORE Compression			SILICONE HOLLOW CORE Compression		
	10%	15%	20%	10%	15%	20%	10%	15%	20%
	1,60	16	26	40	20	33	48		
1,78	26	40	53	22	35	48			
2,00	34	53	77	30	46	59			
2,50	40	66	95	40	59	78			
2,62	29	44	64	23	38	53			
3,00	70	107	140	36	60	82	27	38	50
3,53	54	91	120	32	57	83	28	44	58
4,00	51	82	111	56	87	108	23	36	45
4,50	75	107	139	53	84	110	41	55	65
5,00	91	126	182	39	64	89	50	70	87
5,34	82	117	145	96	138	191	54	77	94
5,50	45	83	116	37	65	93			
5,70	79	116	115	58	88	112			
6,00	86	126	169	53	86	113	46	72	91
6,99	95	135	201	101	135	201	46	63	80
8,00	101	147	213	82	122	163	66	96	121
9,52	115	173	247	84	125	175			
10,00	122	192	281	117	174	246			
12,00	124	194	279	59	93	126			

Figures in N/25mm length

### 6. Compound Selection - Encapsulated Teflex

#### 10. Groove dimensions

**Table 1 - Piston/Rod Sealing Application**

∅	't'	'b'
1.60	1.20	1.90
1.78	1.30	2.30
2.00	1.50	2.60
2.50	1.90	3.20
2.62	2.00	3.40
3.00	2.30	3.90
3.53	2.75	4.50
4.00	3.15	5.20
4.50	3.60	5.80
5.00	4.00	6.50
5.34	4.30	6.90
5.50	4.50	7.10
5.70	4.65	7.40
6.00	4.95	7.80
6.35	5.25	8.20
6.99	5.85	9.10
8.00	6.75	10.40
8.40	7.20	10.50
9.00	7.70	11.70
9.52	8.20	12.30
10.00	8.65	13.00
11.10	9.65	14.30
12.00	10.60	15.60
12.70	11.45	16.80

**Table 2 - Axial Face Sealing Application**

∅	't'	'b'
1.60	1.20 ± 0.05	2.10
1.78	1.30 ± 0.05	2.30
2.00	1.50 ± 0.05	2.60
2.50	1.90 ± 0.05	3.20
2.62	2.00 ± 0.05	3.40
3.00	2.30 ± 0.05	3.90
3.53	2.75 ± 0.05	4.50
4.00	3.15 ± 0.05	5.20
4.50	3.60 ± 0.05	5.80
5.00	4.00 ± 0.05	6.50
5.34	4.30 ± 0.05	6.90
5.50	4.50 ± 0.05	7.10
5.70	4.65 ± 0.05	7.40
6.00	4.95 ± 0.05	7.80
6.35	5.25 ± 0.05	8.20
6.99	5.85 ± 0.05	9.10
8.00	6.75 ± 0.10	10.40
8.40	7.15 ± 0.10	10.90
9.00	7.70 ± 0.10	11.70
9.52	8.20 ± 0.10	12.30
10.00	8.65 ± 0.10	13.00
11.10	9.70 ± 0.10	14.30
12.00	10.60 ± 0.10	15.60
12.70	11.40 ± 0.10	16.70

Table 1

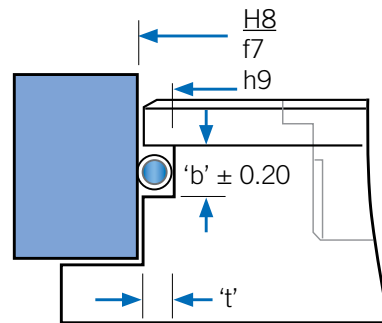

Table 1

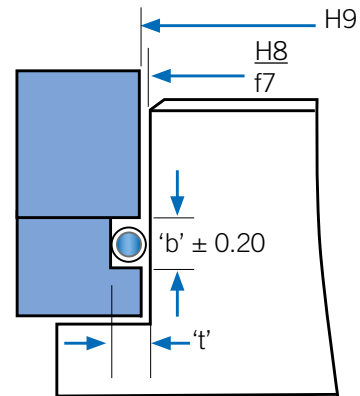
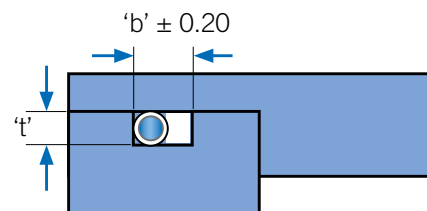

Table 2



## 6. Compound Selection - Encapsulated Teflex

### 11. Approvals

#### FDA: Food and Drug Administration

This data pertains to the US Federal Food and Drug Administration regulations governing the use of fluoropolymers as articles or components intended for use in contact with food.

The Teflon FEP and PFA resins used to produce Teflex may be used as articles or components to contact food in compliance with FDA Regulation 21 CFR 177.1550.

This specification includes acceptance by The United States Department of Agriculture for direct use in contact with meat or poultry food products and Food Industries Supply Association Inc for product contact surfaces for Dairy Equipment.

USP Class VI requirements are met by Teflon FEP and PFA for use in Pharmaceutical Processing.

Teflon FEP is approved for use with potable water under section 5296 certificate no 930716.

#### Teflon FEP - CONFORMITY

21 CFR 177.1550	21 CFR 177.2600	21 CFR 175.105
21 CFR 176.180	21 CFR 177.1520	21 CFR 175.300
21 CFR 176.170		

#### Teflon PFA - CONFORMITY

21 CFR 177.1550	21 CFR 175.105	21 CFR 176.180
21 CFR 175.300	21 CFR 176.170	

Viton® can be produced compliant to FDA.

### 12. Quality control and inspection

ERIKS only uses the very best available materials and components from manufacturers such as Dupont Performance Elastomers. The laser micrometer inspection equipment is state of the art and every single Teflex O-Ring which leaves the warehouse has been individually checked for visual and mechanical compliance. Dimensional inspection AQL is 10% unless otherwise agreed. ERIKS is able to offer 100% control on dimensions.

Prior to dispatch large Teflex O-Rings may be twined and coiled to reduce shipping costs. It is advised to uncoil the ring upon receipt. If this is not done, after some length of time it may be necessary to place the seal in hot water or an oven (max 80°C) for 10-20 minutes to allow the seal to return to shape.



### 6. Compound Selection - Encapsulated Teflex

#### 13. Answers to popular questions

##### Is it possible to produce Teflex O-Rings with an EPDM or NBR core?

It is possible with special EPDM (white or black). Due to the high temperatures involved in the production process it is not possible to produce Teflex O-Rings around normal elastomers.

##### Is 48 hours emergency production possible?

It is possible if we take down the set up of the actual production. So these O-Rings are more expensive.

##### Why are small O-Rings relatively more expensive?

Every O-Ring is made by hand. As one can imagine the very small items have to be manufactured, sized, and inspected in the same way as larger O-Rings but the process is much longer.

##### Are other cross sections possible than the standard ones?

Due to a special process ERIKS produces special cross section sizes. Tooling costs are necessary.

##### Are special core materials possible?

Yes. Now we are able to offer special core materials like Viton(R) GF, USP Class VI or metal detectable grades. Please contact us for more information.

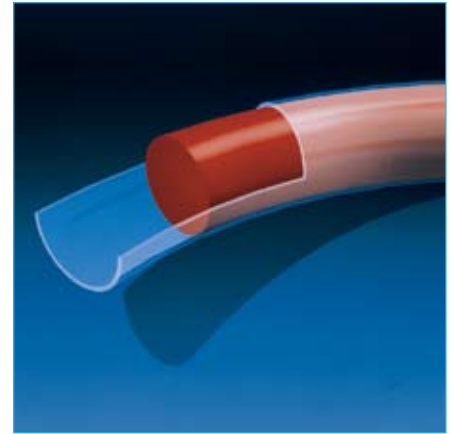

## 6. Compound Selection - Metal C- and O-rings

Metal c- and o-rings are used in a wide range of industrial applications, where the use of elastomeric o-rings are restricted by temperature, corrosion, radiation, pressure, gas permeation or life time requirements.

As an elastomeric o-ring a metal c- or o-ring seals due to its resilience characteristics. Also the sealing performance will increase significantly due to pressure energization. That means that the hydrostatic pressures are used to benefit the self-energization of the seal. Especially at high pressures this becomes a “sealing-advantage” and enables metal c- and o-rings to seal at 200 MPa and more.

### General Properties

- Sizes: Diameters from 5 mm to 7 meter.
- Cross section from 0,79 mm to 12,70 mm.
- Temperature: Cryogenic to +750°C.
- Pressure: From ultra high vacuum to +500 MPa.
- Available in circular, race track, oval and other shapes.
- Excellent resistance to corrosion and radiation.
- Maintains elasticity or spring back over an extended service life.
- Does not suffer from explosive decompression.
- Capable of reaching tightness better than 10<sup>-9</sup> mbar.l/s.
- Radiation resistant.

Resilient metal seals often have to perform under extreme service conditions. Standard solutions as found in this catalogue may not always suffice this requirements. Please get in contact with us in case of any questions.

### Plating and Coating

Platings or coatings are applied to improve the sealing performance of metal seals. Depending on the required tightness, the selected seal, the media to be sealed and the condition of the mating surface, a softer or harder plating or coating shall be chosen. When temperature allows, either PTFE coating or soft silver should be applied.

The soft layer, flows at seal compression into the mating surface irregularities and creates hereby the best seal performance possible.

PTFE coating can achieve leak rates around 10–6 mbar.l/s, measured with the vacuum method.

Metal type plating, like silver, indium, and tin to name a few, can achieve leak rates better than 10<sup>-9</sup> mbar.l/s up to 10<sup>-12</sup> mbar.l/s.

## 6. Compound Selection - Metal C- and O-rings

### Heat Treatment

It is recommended to heat treat all non spring energised metal c- and o-rings. The seals will perform better in the heat treated condition.

Heat treatment of super alloys such as Inconel X750, Inconel 718, Haynes 214, will increase the yield strength of the material. This influences directly the seal performances, because of increasing seating load and a better spring back.

The increased seating load will press the soft plating better into the surface irregularities, thereby creating a better seal.

The higher spring back means that the intimate contact between the seal and the mating surface is maintained longer in case of flange deflection.

Such flange deflection can be a result of high temperatures, high pressures and/or a combination thereof.

Heat treatment is mostly not required for spring energised c-rings and metal o-rings. However some demanding applications in oil and gas environment do require heat treatment to prevent material embrittlement. (Heat treatment according to Nace.)

Annealing and heat treatment also improves the seal's resistance against fatigue under cyclic loads. Structural integrity will be maintained for an extended period of time. Age hardening, annealing and solution and precipitation heat treatment is possible.

Metal o-rings and some spring energised c-rings made from austenitic stainless steels, are not precipitation hardenable. These seals can only be supplied in the work hardened condition. For demanding applications and for temperatures above +400°C, it is advised to use high alloy steels only.

**Heat Treatment Codes for Jacket and Spring Materials**

Material Code	HT-1	HT-2	HT-3	HT-4	HT-5	HT-6	HT-7	HT-8
1 Nickel alloy X-750	X	X		X				
2 Nickel alloy 718	X	X		X	X			
3 321 SS	X							
4 Nickel alloy 600	X		X					
5 304 SS	X							
6 304 SS, high tensile	X							
7 316 SS	X							
8 Hastelloy	X							
9 302 SS	X							
A ELGILLOY	X							X
B HAYNES 214	X						X	
C ALUMINIUM 1050	X		X					
D ALLOY 625	X					X		
E NIMONIC 90	X							
F HASTELLOY C-276	X				X			
G HAYNES 188	X							

- HT-1 Work Hardened
- HT-2 Age Hardened, short cycle
- HT-3 Annealing
- HT-4 Solution and Precipitation Heat treatment
- HT-5 Nace Heat treatment, Hardness max 40 HRC, Alloy 718
- HT-6 Nace Solution Annealing
- HT-7 Stress Relief
- HT-8 Age Hardened, Hardness max for NACE 62 HRC

### 6. Compound Selection - Metal C- and O-rings

#### Types of Metal C- and O-ring Seals

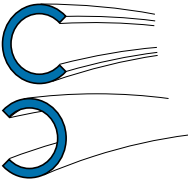
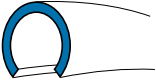
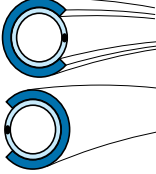
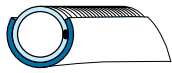
Metal C-rings			
	Code	Description	Features
	CI CE	Metal C-ring Internal (CI) or External (CE) Pressure Face Seal	Designed for high pressure (system pressure energised). They require low bolting load and have good spring back properties
	CA	Metal C-ring, Radial Seal for Axial Pressure	Designed to seal shaft to bore. Close tolerances on both shaft and bore are required.
	CSI CSE	Spring Energised Metal C-ring, Internal (CSI) or External (CSE) Pressure Face Seal	Designed for high pressure and excellent tightness performance (system pressure energised). They require high bolting load and have good spring back properties.
	CSA	Spring Energised Metal C-ring, Radial Seal for Axial Pressure	Designed to seal shaft to bore. Close tolerances on both shaft and bore are required.

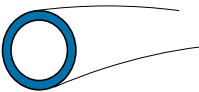
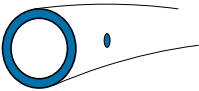
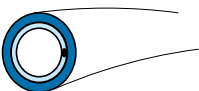
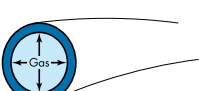
Metal O-rings			
	Code	Description	Features
	OI OE	Metal O-ring Internal (OI) or External (OE) Pressure Face Seal	Designed for lower pressure ranges. Avoids ingress of the working fluid into the seal, Moderate load, moderate pressure capability.
	OVI OVE	Metal O-ring internally (OVI) or externally (OVE) vented Face Seal	Designed for higher pressure. Besides the own seating load the seal is also energised by the system pressure.
	OSI OSE	Metal O-ring externally (OSE) or internally (OSI) spring-energised Face Seal and Radial Seal	Designed for extreme low leakage at moderate pressures.
	OGI OGE	Metal O-ring externally (OGE) or internally (OGI) gas-energised Face Seal	For high temperature and moderate pressure applications.

### 6. Compound Selection - Metal C- and O-rings

#### Load and Spring Back

The selection of the most suitable seal for extreme service conditions is often a delicate trade off between load and spring back of the seal. The compression load or seating load has a direct relation with the obtainable tightness where as the spring back of the seal determines how well this tightness is maintained with varying temperatures and pressures.

For a given seal cross section and seal type it is generally true that with maximum load the spring back is lowest. And of course that seal with minimum load will generate the highest spring back.

Looking at a metal o-ring made from stainless steel, one with a thin wall and the other with a thick wall, the one with the thin wall will require lower load to be compressed to groove depth than the one with the thick wall, where the spring back of the latter will be lower than the one with the thin wall.

Again looking at the same cross section metal o-ring, a seal made from Inconel X750 or Inconel 718 will have a higher load and higher spring back than a similar wall thickness metal o-ring made from stainless steel.

Going over to metal c-rings, there is a certain similarity with spring back and seating load. The big difference is that metal c-rings compared with the same cross section metal o-rings, typically generate a lower load, and thus a better spring back than metal o-rings.

To overcome the low load of metal c-rings, the spring energised metal c-ring was developed. This seal generates a relative high and uniform seating load with a relative high spring back.

#### Compression or Seating Load

The compression or seating load is expressed in N/mm seal circumference. The higher the load, the better the sealing performance will be. Soft plating requires lower load than harder plating.

Rough surface finish of the sealing faces require a higher load to obtain similar seal performance.

Non plated seals typically require extreme high loads to obtain technical tightness. It will be difficult, regardless the applied load to obtain a high tightness with unplated seals.

#### Tightness, Plating

Depending on the required tightness, medium to be sealed and temperature, a different plating or coating may be selected.

For tightness better than 10-9 mbar.l/s a soft plating is always required. Indium and Tin are soft platings. PTFE is a soft coating too, but the obtainable tightness is limited to 10-6 mbar.l/s., because of the own porosity of PTFE.

Silver, Gold and Copper are medium soft and require a higher load seal to obtain tightness ranges of 10-9 mbar.l/s. Silver is the most common used plating. Nickel plating, being the hardest plating requires a high load seal selection.

Plating Code	Plating/Coating
S	Silver – max. 430°C
G	Gold – max. 930°C
C	Copper – max. 930°C
N	Nickel – max. 1200°C
L	Lead – max. 200°C
T	PTFE – max. 290°C
SN	Tin – max. 200°C
IN	Indium – max. 130°C

Thickness Code	Plating Thickness in µm
30	10-30
50	30-50
70	50-70

#### Flange Rotation or Lift Off

Big diameters and high temperatures play a decisive role in the selection of a metal seal. Flange rotation or lift off occurs under high pressure. The higher the pressure and the bigger the flange diameters, subjected to this pressure, the bolts will be subjected to a quite high stress and strain, resulting in flange rotation or lift off.

For such service conditions the biggest possible cross section for the given diameter should be selected, in order to have the best possible spring back characteristics.

#### Summary Seal Design

- The groove surface finish for any selected seal should be equal or better than  $R_a = 1,8$ . For tightness equal or better than 10-9 mbar.l/s, a surface finish better than  $R_a = 0,8$  should be applied.
- Always select the biggest possible cross section for a given diameter.
- Selected the softest plating allowed for the application. If bold load permits, choose the highest seal load available when medium soft plating such as silver, gold or copper is selected.
- For temperatures above 350°C it is advised to use Inconel as base materials.
- For pressures above 35 MPa it is advised to use c-ring type seals or vented o-rings, both with or without spring energising, depending on the required tightness.
- For high temperature applications and when an o-ring type seal is required a gas filled seal may be the better option.

## 6. Compound Selection - Metal C- and O-rings

### Groove and Seal Dimensions – Metal O-rings

Internal Pressure Face Seals (OI, OVI, OGI, OSI)										
Seal Dimensions				Groove Dimensions					Load	SB
AS			MT	DC	DG	GD	WG	R		
Axial Section	Tolerance on AS	Material Code	Material Thickness	Diametrical Clearance	Groove Diam. (range)	Groove Depth (min/max)	Groove Width (min)	Radius (max)	N/mm Circumference*	Spring Back in mm
0,89	+0,08/-0,03	M	0,15	0,20	6,35-25	0,64-0,69	1,40	0,25	140	0,03
1,19	+0,08/-0,03	H	0,20	0,25	10-50	0,94-1,02	1,78	0,30	100	0,03
1,57	+0,08/-0,03	L	0,15	0,28	10-200	1,14-1,27	2,29	0,38	60	0,06
		M	0,25	"	"	"	"	"	140	0,05
		H	0,36	"	"	"	"	"	200	0,04
2,39	+0,08/-0,03	L	0,15	0,33	13-200	1,88-2,01	3,18	0,51	40	0,06
		M	0,25	"	"	"	"	"	100	0,05
		H	0,46	"	"	"	"	"	200	0,04
3,18	+0,08/-0,0	M	0,25	0,43	25-400	2,54-2,67	4,06	0,76	60	0,08
		H	0,51	"	"	"	"	"	180	0,05
3,96	+0,10	M	0,41	0,61	75-650	3,18-3,30	5,08	1,27	90	0,10
		H	0,51	"	"	"	"	"	135	0,08
4,78	+0,13	M	0,51	0,71	100-800	3,84-3,99	6,35	1,27	90	0,14
		H	0,64	"	"	"	"	"	200	0,10
6,35	+0,13	M	0,64	0,76	200-1200	5,05-5,28	8,89	1,52	100	0,20
		H	0,81	"	"	"	"	"	250	0,15
9,53	+0,13	M	0,97	1,02	300-2000	8,26-8,51	12,7	1,52	150	0,25
		H	1,24	"	"	"	"	"	300	0,20
12,70	+0,15	M	1,27	1,27	800-3000	11,05-11,43	16,51	1,52	200	0,30
		H	1,65	"	"	"	"	"	350	0,20

\* Load and spring back figures are based on Inconel X750 in the age hardened condition. 321 stainless steel will only generate 1/3 of the given Inconel figures. Actual load figures and to a lesser extend spring back can differ hugely from the given data. Tolerances on groove depth, plating, diametrical clearance and differences in material batches can create differences of up to 100% for the smaller cross sections, down to 50% for the bigger cross section.

## 6. Compound Selection - Metal C- and O-rings

### Groove and Seal Dimensions – Metal O-rings

**Attention:** Internal pressure seal: Diameter Seal Outside = Reference

**Formula:**  $DSO = DG - DC - (2 \times \text{Plating Thickness})$

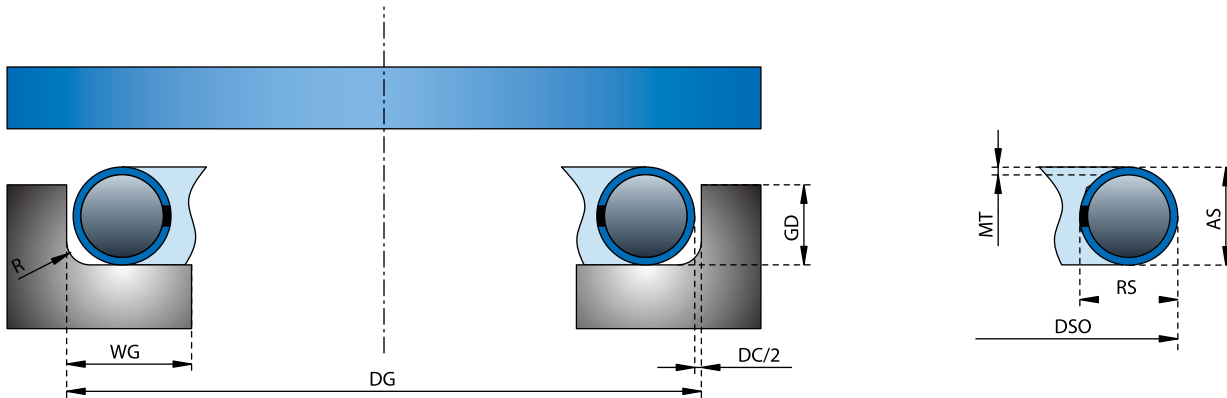

### Standard Materials and Codes

Jacket		Spring	
Code	Material	Code	Material
1	Alloy X-750*	0	None
3	321 SS	1	Alloy X-750*
4	Alloy 600	2	Alloy 718
		9	302 SS

\* X-750 will become obsolete. Other materials on request.



## 6. Compound Selection - Metal C- and O-rings

### Groove and Seal Dimensions – Metal O-rings

External Pressure Face Seals (OE, OVE, OGE, OSE)										
Seal Dimensions				Groove Dimensions					Load	SB
AS			MT	DC	DG	GD	WG	R		
Axial Section	Tolerance on AS	Material Code	Material Thickness	Diametrical Clearance	Groove Diam. (range)	Groove Depth (min/max)	Groove Width (min)	Radius (max)	N/mm Circumference*	Spring Back in mm
0,89	+0,08/-0,03	M	0,15	0,20	6,35-25	0,64-0,69	1,40	0,25	140	0,03
1,19	+0,08/-0,03	H	0,20	0,25	10-50	0,94-1,02	1,78	0,30	100	0,03
1,57	+0,08/-0,03	L	0,15	0,28	10-200	1,14-1,27	2,29	0,38	60	0,06
		M	0,25	"	"	"	"	"	140	0,05
		H	0,36	"	"	"	"	"	200	0,04
2,39	+0,08/-0,03	L	0,15	0,33	13-200	1,88-2,01	3,18	0,51	40	0,06
		M	0,25	"	"	"	"	"	100	0,05
		H	0,46	"	"	"	"	"	200	0,04
3,18	+0,08/-0,03	M	0,25	0,43	25-400	2,54-2,67	4,06	0,76	60	0,08
		H	0,51	"	"	"	"	"	180	0,05
3,96	+0,10	M	0,41	0,61	75-650	3,18-3,30	5,08	1,27	90	0,10
		H	0,51	"	"	"	"	"	135	0,08
4,78	+0,13	M	0,51	0,71	100-800	3,84-3,99	6,35	1,27	95	0,14
		H	0,64	"	"	"	"	"	200	0,10
6,35	+0,13	M	0,81	0,76	200-1200	5,05-5,28	8,89	1,52	100	0,20
		H	0,64	"	"	"	"	"	250	0,15
9,53	+0,13	M	0,97	1,02	300-2000	8,26-8,51	12,70	1,52	150	0,25
		H	1,24	"	"	"	"	"	300	0,20
12,70	+0,15	M	1,27	1,27	800-3000	11,05-11,43	16,51	1,52	200	0,30
		H	1,65	"	"	"	"	"	350	0,20

\* Load and spring back figures are based on Inconel X750 in the age hardened condition. 321 stainless steel will only generate 1/3 of the given Inconel figures. Actual load figures and to a lesser extent spring back can differ hugely from the given data. Tolerances on groove depth, plating, diametrical clearance and differences in material batches can create differences of up to 100% for the smaller cross sections, down to 50% for the bigger cross section.

## 6. Compound Selection - Metal C- and O-rings

### Groove and Seal Dimensions – Metal O-rings

**Attention:** External pressure seal: Diameter Seal Inside = Reference

**Formula:**  $DSI = DG + DC + (2 \times \text{Plating Thickness})$

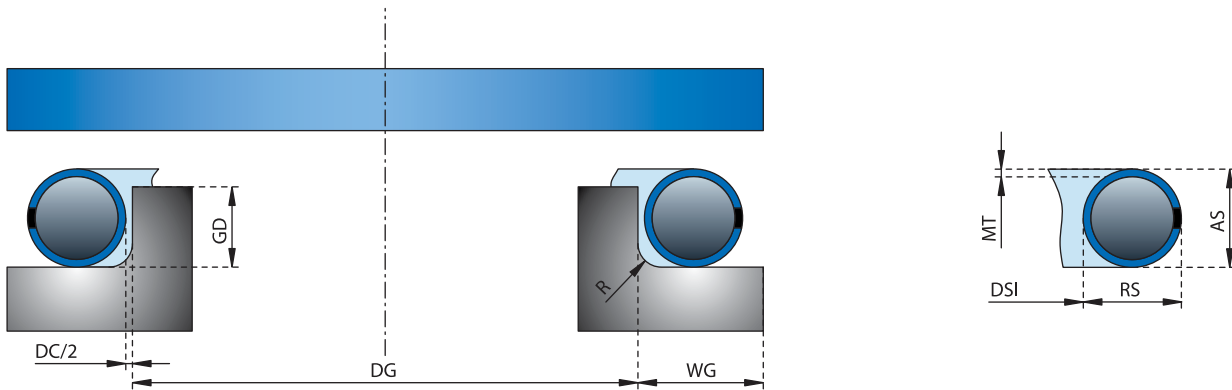

### Standard Materials and Codes

Jacket		Spring	
Code	Material	Code	Material
1	Alloy X-750*	0	None
3	321 SS	1	Alloy X-750*
4	Alloy 600	2	Alloy 718
		9	302 SS

\* X-750 will become obsolete. Other materials on request.

## 6. Compound Selection - Metal C- and O-rings

### Groove and Seal Dimensions – Metal C-rings

Internal Pressure Face Seal (CI)											
Seal Dimensions						Groove Dimensions				Load	SB
AS		RS	Material Code	MT	DC	DG	GD	WG	R		
Axial Section	Tolerance on AS	Radial Section		Material Thickness	Diametrical Clearance	Groove Diameter (range)	Groove Depth (min/max)	Groove Width (min)	Radius (max)	N/mm Circumference*	Spring Back in mm
0,79	+/-0,05	0,71	M	0,15	0,05	6-25	0,64-0,69	1,02	0,25	30	0,04
			H	0,18	"	"	"	"	50	"	
1,19	+/-0,05	0,96	M	0,15	0,07	8-50	0,94-1,02	1,40	0,30	20	0,03
			H	0,2	"	"	"	"	35	"	
1,57	+/-0,05	1,26	M	0,15	0,10	10-200	1,27-1,37	1,91	0,38	10	0,05
			H	0,25	"	"	"	"	40	"	
2,39	+/-0,05	1,91	M	0,25	0,15	13-400	1,91-2,01	2,67	0,51	35	0,04
			H	0,38	"	"	"	"	65	"	
2,79	+/-0,05	2,25	M	0,25	0,15	200-500	2,23-2,31	3,10	0,55	30	0,12
3,18	+/-0,08	2,54	M	0,38	0,20	25-600	2,54-2,67	3,43	0,76	45	0,15
			H	0,51	"	"	"	"	100	0,13	
3,96	+/-0,08	3,17	M	0,41	0,25	32-750	3,18-3,30	4,32	1,27	40	0,20
			H	0,61	"	"	"	"	110	0,17	
4,78	+/-0,10	3,82	M	0,51	0,30	75-900	3,84-3,99	5,08	1,27	65	0,22
			H	0,76	"	"	"	"	150	0,18	
5,60	+/-0,10	4,50	M	0,51	0,30	75-1000	4,48-4,65	5,90	1,27	55	0,22
6,35	+/-0,10	5,08	M	0,64	0,40	100-1200	5,08-5,28	6,6	1,52	75	0,30
			H	0,97	160	"	"	"	"	"	0,27
7,90	+/-0,10	6,32	M	0,64	0,50	100-1500	6,32-6,58	8,22	1,52	65	0,30
9,53	+/-0,10	7,62	M	0,97	0,60	300-2000	7,62-8,03	9,65	1,52	120	0,40
			H	1,27	"	"	"	"	250	0,32	
12,70	+/-0,13	10,16	M	1,27	0,80	600-3000	10,16-10,67	12,7	1,52	150	0,55
			H	1,65	"	"	"	"	250	0,48	

\* Load and spring back figures are based on Inconel X750 in the age hardened condition. Actual load figures and to a lesser extend spring back can differ hugely from the given data. Tolerances on groove depth, plating, diametrical clearance and differences in material batches can create differences of up to 100% for the smaller cross sections, down to 50% for the bigger cross section.

### 6. Compound Selection - Metal C- and O-rings

#### Groove and Seal Dimensions – Metal O-rings

**Attention:** Internal pressure seal: Diameter Seal Inside = Reference

**Formula:**  $DSO = DG - DC - (2 \times \text{Plating Thickness})$

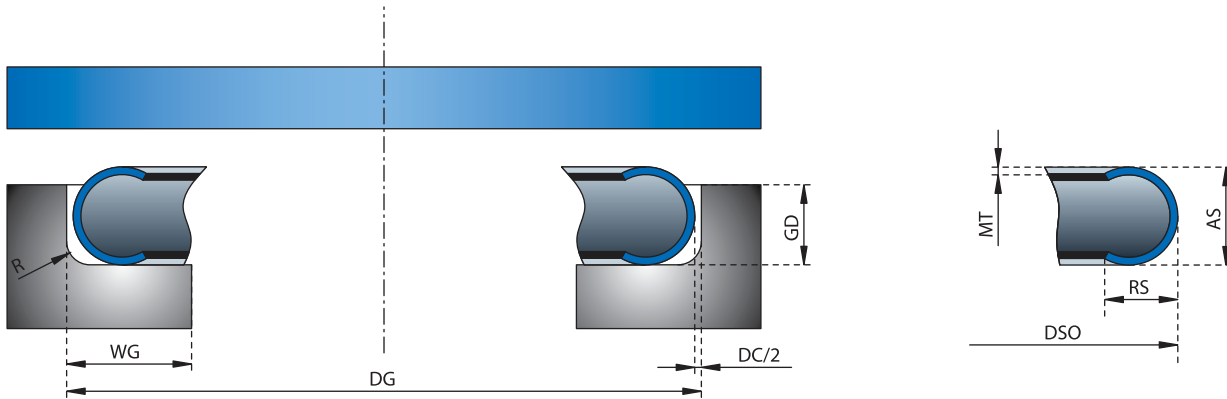

#### Standard Materials and Codes

Jacket		Spring	
Code	Material	Code	Material
1	Alloy X-750*	0	-
2	Alloy 718	0	-
5	304 SS	0	-

\* X-750 will become obsolete. Other materials on request.

## 6. Compound Selection - Metal C- and O-rings

### Groove and Seal Dimensions – Metal C-rings

External Pressure Face Seal (CE)											
Seal Dimensions						Groove Dimensions				Load	SB
AS		RS	Material Code	MT	DC	DG	GD	WG	R		
Axial Section	Tolerance on AS	Radial Section		Material Thickness	Diametrical Clearance	Groove Diameter (range)	Groove Depth (min/max)	Groove Width (min)	Radius (max)	N/mm Circumference*	Spring Back in mm
0,79	+/-0,05	0,71	M	0,15	0,05	6-25	0,64-0,69	1,02	0,25	30	0,04
			H	0,18	"	"	"	"	50	"	
1,19	+/-0,05	0,96	M	0,15	0,07	8-50	0,94-1,02	1,40	0,30	20	0,03
			H	0,20	"	"	"	"	35	"	
1,57	+/-0,05	1,26	M	0,15	0,10	10-200	1,27-1,37	1,91	0,38	10	0,05
			H	0,25	"	"	"	"	40	"	
2,39	+/-0,05	1,91	M	0,25	0,15	13-400	1,91-2,01	2,67	0,51	35	0,04
			H	0,38	"	"	"	"	65	"	
2,79	+/-0,05	2,25	M	0,25	0,15	200-500	2,23-2,31	3,10	0,55	30	0,12
3,18	+/-0,08	2,54	M	0,38	0,20	25-600	2,54-2,67	3,43	0,76	45	0,15
			H	0,51	"	"	"	"	100	0,13	
3,96	+/-0,08	3,17	M	0,41	0,25	32-750	3,18-3,30	4,32	1,27	40	0,20
			H	0,61	"	"	"	"	110	0,17	
4,78	+/-0,10	3,82	M	0,51	0,30	75-900	3,84-3,99	5,08	1,27	65	0,22
			H	0,76	"	"	"	"	150	0,18	
5,60	+/-0,10	4,50	M	0,51	0,30	75-1000	4,48-4,65	5,90	1,27	55	0,22
6,35	+/-0,10	5,08	M	0,64	0,40	100-1200	5,08-5,28	6,6	1,52	75	0,30
			H	0,97	"	"	"	"	160	0,27	
7,90	+/-0,10	6,32	M	0,64	0,50	100-1500	6,32-6,58	8,22	1,52	65	0,30
9,53	+/-0,10	7,62	M	0,97	0,60	300-2000	7,62-8,03	9,65	1,52	120	0,40
			H	1,27	"	"	"	"	250	0,32	
12,70	+/-0,13	10,16	M	1,27	0,80	600-3000	10,16-10,67	12,7	1,52	150	0,55
			H	1,65	"	"	"	"	250	0,48	

\* Load and spring back figures are based on Inconel X750 in the age hardened condition. Actual load figures and to a lesser extend spring back can differ hugely from the given data. Tolerances on groove depth, plating, diametrical clearance and differences in material batches can create differences of up to 100% for the smaller cross sections, down to 50% for the bigger cross section.

## 6. Compound Selection - Metal C- and O-rings

### Groove and Seal Dimensions – Metal O-rings

**Attention:** Internal pressure seal: Diameter Seal Outside = Reference

**Formula:**  $DSI = DG + DC + (2 \times \text{Plating Thickness})$

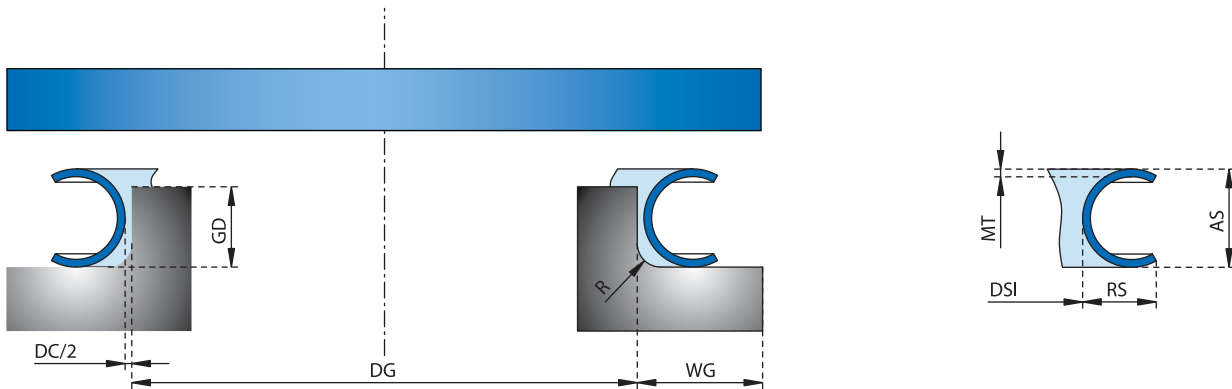

### Standard Materials and Codes

Jacket		Spring	
Code	Material	Code	Material
1	Alloy X-750*	0	-
2	Alloy 718	0	-
5	304 SS	0	-

\* X-750 will become obsolete. Other materials on request.

### 6. Compound Selection - Metal C- and O-rings

#### Groove and Seal Dimensions – Metal C-rings

Spring Energised Internal Pressure Face Seals (CSI)

Seal Dimensions						Groove Dimensions				Load	SB
AS		RS		MT	DC	DG	GD	WG	R		
Axial Section	Tolerance on AS	Radial Section	Material Code	Material Thickness	Diametrical Clearance	Groove Diameter (range)	Groove Depth (min/max)	Groove Width (min)	Radius (max)	N/mm Circumference*	Spring Back in mm
1,57	+/-0,05	1,52	M/H	0,15	0,15	20-280	1,27-1,32	2,05	0,35	200	0,10
2,00	+/-0,05	1,85	M/H	0,25	0,20	20-300	1,60-1,68	2,50	0,40	180	0,12
2,39	+/-0,05	2,24	M/H	0,25	0,20	25-400	1,91-2,01	3,10	0,50	160	0,15
2,79	+/-0,05	2,64	M/H	0,25	0,25	25-500	2,23-2,34	3,60	0,50	200	0,18
3,18	+/-0,08	2,90	M/H	0,38	0,30	25-600	2,54-2,67	4,10	0,75	160	0,20
3,96	+/-0,08	3,60	M/H	0,41	0,41	32-750	3,18-3,30	5,10	1,20	210	0,25
4,78	+/-0,10	4,49	M/H	0,51	0,46	75-900	3,84-3,99	6,20	1,20	250	0,28
5,60	+/-0,10	5,19	M/H	0,51	0,48	75-1000	4,48-4,70	7,30	1,20	200	0,30
6,35	+/-0,10	5,81	M/H	0,64	0,51	100-1800	5,08-5,28	8,30	1,50	340	0,36
7,90	+/-0,10	7,25	M/H	0,64	0,70	150-3000	6,32-6,58	10,40	1,50	300	0,40
9,53	+/-0,10	8,66	M/H	0,97	0,75	300-3000	7,62-8,03	12,40	1,50	430	0,43
12,70	+/-0,13	11,53	M/H	1,27	1,00	600-7600	10,16-10,67	16,50	1,50	500	0,56

\* Load and spring back figures are based on Inconel /Inconel Jacket and spring. Actual load figures and to a lesser extend spring back can differ hugely from the given data. Tolerances on groove depth, plating, diametrical clearance and differences in material batches can create differences of up to 100% for the smaller cross sections, down to 50% for the bigger cross section. Load figures only valid for "M" (medium duty) spring.

**Attention:** Internal pressure seal: Diameter Seal Outside = Reference

**Formula:**  $DSO = DG - DC - (2 \times \text{Plating Thickness})$

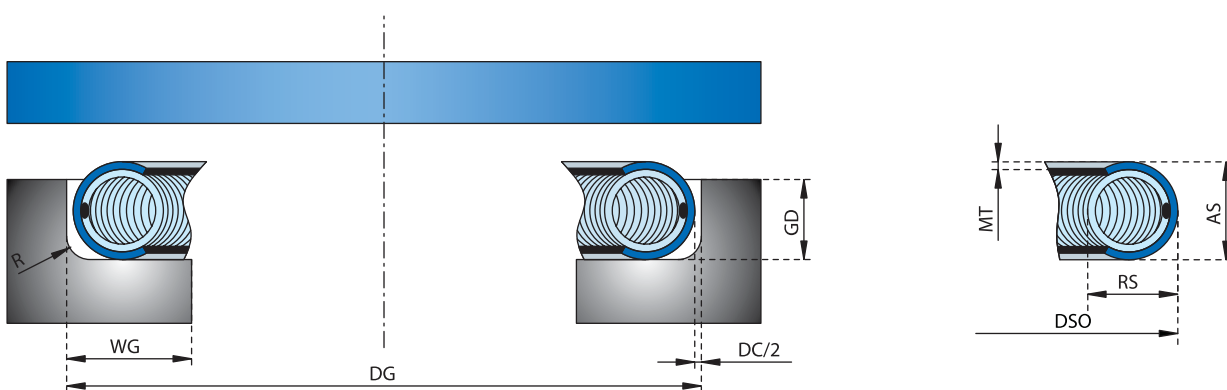

#### Standard Materials and Codes

Jacket		Spring	
Code	Material	Code	Material
1	Alloy X-750*	1	Alloy X-750*
2	Alloy 718	2	Alloy 718
5	304 SS	9	302 SS
-	-	A	Elgiloy
-	-	E	Nimonic

\* X-750 will become obsolete. Other materials on request.



### 6. Compound Selection - Metal C- and O-rings

#### Groove and Seal Dimensions – Metal C-rings

Spring Energised External Pressure Face Seals (CSE)

Seal Dimensions						Groove Dimensions				Load	SB
AS		RS	Material Code	MT	DC	DG	GD	WG	R		
Axial Section	Tolerance on AS	Radial Section		Material Thickness	Diametrical Clearance	Groove Diameter (range)	Groove Depth (min/max)	Groove Width (min)	Radius (max)	N/mm Circumference*	Spring Back in mm
1,57	+/-0,05	1,52	M/H	0,15	0,15	20-280	1,27-1,32	2,05	0,35	200	0,10
2,00	+/-0,05	1,85	M/H	0,25	0,20	20-300	1,60-1,68	2,50	0,40	180	0,12
2,39	+/-0,05	2,24	M/H	0,25	0,20	25-400	1,91-2,01	3,10	0,50	160	0,15
2,79	+/-0,05	2,64	M/H	0,25	0,25	25-500	2,23-2,34	3,60	0,50	200	0,18
3,18	+/-0,08	2,90	M/H	0,38	0,30	25-600	2,54-2,67	4,10	0,75	160	0,20
3,96	+/-0,08	3,60	M/H	0,41	0,41	32-750	3,18-3,30	5,10	1,20	210	0,25
4,78	+/-0,10	4,49	M/H	0,51	0,46	75-900	3,84-3,99	6,20	1,20	250	0,28
5,60	+/-0,10	5,19	M/H	0,51	0,48	75-1000	4,48-4,70	7,30	1,20	200	0,30
6,35	+/-0,10	5,81	M/H	0,64	0,51	100-1800	5,08-5,28	8,30	1,50	340	0,36
7,90	+/-0,10	7,25	M/H	0,64	0,70	150-3000	6,32-6,58	10,40	1,50	300	0,40
9,53	+/-0,10	8,66	M/H	0,97	0,75	300-3000	7,62-8,03	12,40	1,50	430	0,43
12,70	+/-0,13	11,53	M/H	1,27	1,00	600-7600	10,16-10,67	16,50	1,50	500	0,56

\* Load and spring back figures are based on Inconel /Inconel Jacket and spring. Actual load figures and to a lesser extend spring back can differ hugely from the given data. Tolerances on groove depth, plating, diametrical clearance and differences in material batches can create differences of up to 100% for the smaller cross sections, down to 50% for the bigger cross section. Load figures only valid for "M" (medium duty) spring.

**Attention:** Internal pressure seal: Diameter Seal Inside = Reference

**Formula:** DSI = DG + DC + (2 x Plating Thickness)

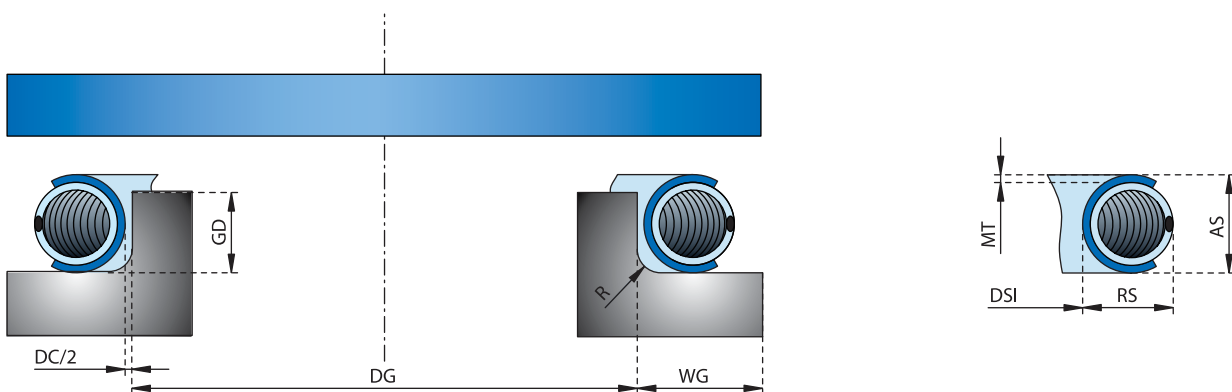

#### Standard Materials and Codes

Jacket		Spring	
Code	Material	Code	Material
1	Alloy X-750*	1	Alloy X-750*
2	Alloy 718	2	Alloy 718
5	304 SS	9	302 SS
-	-	A	Elgiloy
-	-	E	Nimonic

\* X-750 will become obsolete. Other materials on request.

### 6. Compound Selection - Metal C- and O-rings

#### Groove and Seal Dimensions – Metal C-rings

Radial Seals for Axial Pressure (CA)

Groove Dimensions							Seal Dimensions					
	BD		SD		WG	R		RS	MT	DSO	DSI	
Bore Diameter (range)	Bore Diameter	Tolerance on BD	Shaft/Rod Diameter	Tolerance on SD	Groove Width (min)	Radius (max)	Material Code	Radial Section	Material	Diameter Seal Outside	Diameter Seal Inside	Tolerance on DSO and DSI
12,70-38,00	SD + 3,12	+0,03	BD - 3,12	-0,03	1,3	0,38	1.57M	1,64	0,15	BD + 0,08	DSO - 3,28	+/-0,03
38,01-45,00	SD + 3,07	+0,03	BD - 3,07	-0,03	1,3	0,38	1.57M	1,64	0,15	BD + 0,10	DSO - 3,28	+/-0,03
30,00-38,00	SD + 4,70	+0,03	BD - 4,70	-0,03	1,98	0,51	2.39M	2,42	0,25	BD + 0,08	DSO - 4,85	+/-0,03
38,01-85,00	SD + 4,65	+0,03	BD - 4,65	-0,03	1,98	0,51	2.39M	2,42	0,25	BD + 0,10	DSO - 4,85	+/-0,03
50,00-85,00	SD + 6,25	+0,03	BD - 6,25	-0,03	2,64	0,76	3.19M	3,22	0,38	BD + 0,10	DSO - 6,45	+/-0,03
85,01-150,00	SD + 6,15	+0,05	BD - 6,15	-0,05	2,64	0,76	3.19M	3,22	0,38	BD + 0,15	DSO - 6,45	+/-0,05
150,01-200,00	SD + 6,05	+0,05	BD - 6,05	-0,05	2,64	0,76	3.19M	3,22	0,38	BD + 0,20	DSO - 6,45	+/-0,05
85,00-150,00	SD + 7,72	+0,05	BD - 7,72	-0,05	3,28	1,27	3.96M	4,01	0,38	BD + 0,15	DSO - 8,09	+/-0,05
150,01-250,00	SD + 7,62	+0,05	BD - 7,62	-0,05	3,28	1,27	3.96M	4,01	0,38	BD + 0,20	DSO - 8,09	+/-0,05
100,00-150,00	SD + 9,32	+0,05	BD - 9,32	-0,05	3,96	1,27	4.78M	4,81	0,51	BD + 0,15	DSO - 9,63	+/-0,05
150,01-300,00	SD + 9,22	+0,05	BD - 9,22	-0,05	3,96	1,27	4.78M	4,81	0,51	BD + 0,20	DSO - 9,63	+/-0,05
150,00-300,00	SD + 12,40	+0,05	BD - 12,40	-0,05	5,28	1,52	6.35M	6,40	0,64	BD + 0,20	DSO - 12,80	+/-0,05

Bore/Shaft concentricity: for bore < 85 mm: 0,015 mm. For bore >85 mm: 0,03 mm.  
Leading edge, shaft and bore side required.

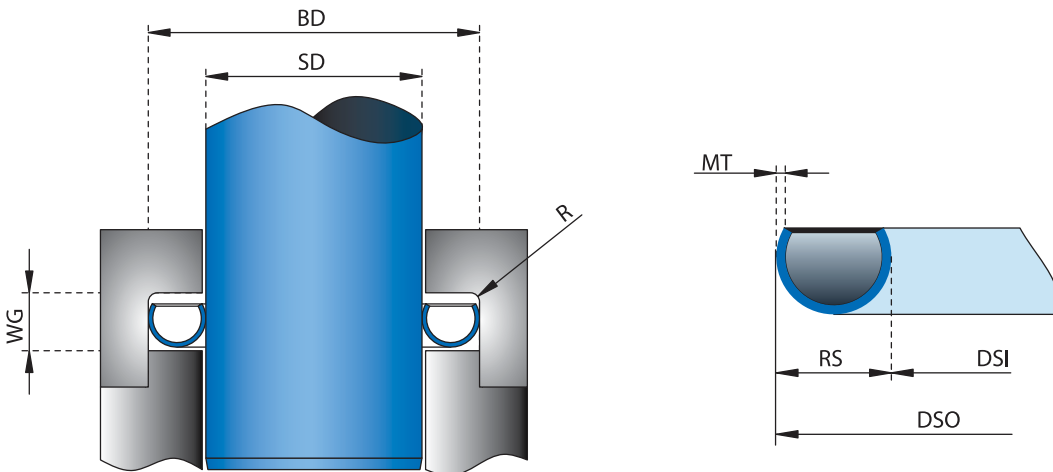

**Attention:** Axial pressure seal: Diameter Seal Outside = Reference

The seal diameter is always the outside diameter without plating.  
Select the desired cross section in relation with the bore diameter.

- Starting from the shaft size 80,70 the DSO (diameter seal outside) equals shaft size 80,70 + 6,45 DSO = 87,15.
- Starting from the bore diameter 87,00 the DSO (diameter seal outside) equals bore size 87,00 + 0,15 DSO = 87,15.
- Plating thickness on radial seals should be limited to 50 microns. Seal diameters remain unchanged for plated seals.

#### Standard Materials and Codes

Jacket		Spring	
Code	Material	Code	Material
1	Alloy X-750*	1	Alloy X-750*
2	Alloy 718	2	Alloy 718
5	304 SS	9	302 SS
-	-	A	Elgiloy
-	-	E	Nimonic

\* X-750 will become obsolete. Other materials on request.

## 6. Compound Selection - Metal C- and O-rings

### Groove Tolerances for Face Type Seals

The actual as produced seal diameter shall be as close as possible to the groove diameter.

By compressing the seal in the groove, the seal outside diameter for internal pressure seals will try to grow and the seal inside diameter for external pressure will try to shrink.

This phenomena is covered by the DC or diametrical clearance. The DC will give allowance for this increase or decrease of the seal diameter.

The seal tolerance and also groove tolerance shall be kept as small as possible. It is better for the seal performance to keep the DC in compressed condition as small as possible.

Ideally, once compressed the seal outer diameter should slightly touch the groove outer diameter or for an external pressure seal the inner seal diameter should slightly touch the groove ID.

**Internal Pressure  
Groove Outer Diameter Tolerances**

Seal Cross Section	O-ring	C-ring	C-ring Spring Energised
0,79	+ 0,05	+ 0,05	-
0,89	+ 0,10	+ 0,05	-
1,19	+ 0,10	+ 0,08	-
1,57	+ 0,10	+ 0,08	-
2,00	-	-	+ 0,10
2,39	+ 0,15	+ 0,10	+ 0,10
3,18	+ 0,15	+ 0,10	+ 0,13
3,96	+ 0,15	+ 0,13	+ 0,15
4,78	+ 0,20	+ 0,15	+ 0,15
5,60	-	+ 0,20	+ 0,20
6,35	+ 0,20	+ 0,20	+ 0,20
7,90	+ 0,20	+ 0,20	+ 0,20
9,53	+ 0,25	+ 0,25	+ 0,25
12,70	+ 0,25	+ 0,25	+ 0,25

**External Pressure  
Groove Inner Diameter Tolerances**

Seal Cross Section	O-ring	C-ring	C-ring Spring Energised
0,79	- 0,05	- 0,05	-
0,89	- 0,10	- 0,05	-
1,19	- 0,10	- 0,08	-
1,57	- 0,10	- 0,08	-
2,00	-	-	- 0,10
2,39	- 0,15	- 0,10	- 0,10
3,18	- 0,15	- 0,10	- 0,13
3,96	- 0,15	- 0,13	- 0,15
4,78	- 0,20	- 0,15	- 0,15
5,60	-	- 0,20	- 0,20
6,35	- 0,20	- 0,20	- 0,20
7,90	- 0,20	- 0,20	- 0,20
9,53	- 0,25	- 0,25	- 0,25
12,70	- 0,25	- 0,25	- 0,25

### 6. Compound Selection - Datasheets

All ERIKS standard and some special O-ring compounds have data sheets with measured values of specific gravity, hardness, tensile strength, elongation at break, compression set, low temperature, and heat ageing in different test circumstances. Any specific data sheet can be obtained upon request.

For several reasons data sheets can sometimes lead to considerable confusion. Manufacturers generally state values measured on test slabs or test buttons. Though these test slabs are made of the same rubber compound as the O-ring, some factors however, are completely different: vulcanisation time, vulcanisation temperature, post-curing time, and size. The vulcanisation time of such a slab can be 20 minutes, whereas the moulding/vulcanisation time of an O-ring - for economical reasons - can only be 2 minutes. Measuring results from a slab will give different values than measuring on an O-ring.

ERIKS has therefore decided that whenever possible most of their data sheets should show values based on measurements made on O-rings. This gives the customer a better picture of the properties to be expected from the O-ring. To put it in other words: the data sheet with values measured on slabs demonstrates what properties the O-ring could have, if produced under the most ideal conditions. ERIKS, however, states the real sealing performance of the O-rings.

This can be illustrated as follows: in most of the data sheets you will find the compression set values measured on slabs of .25 inch. (6 mm) thickness, e.g. 12%. If measured under the same conditions, an O-ring of .139 inch (3.53 mm) will have a value of 19 to 25%. For determining the service life ERIKS has based their measurements on O-rings with a cross section of .139 inch (3.53 mm). The other cross sections have been extrapolated from these values.

These differences also apply to the other values stated. It is therefore very dangerous to compare values of data sheets without knowing the exact testmethod. It is always better to carry out tests on the O-ring itself in the application rather than on a test specimen.



[www.o-ring.info](http://www.o-ring.info)  
for all our data sheets

### 6. Compound Selection

#### O-ring compounds - Field of Application

Most of the preceding parts in this handbook have dealt with selecting the best rubber compound for a given application. Here is information to understand the factors involved in the process and to provide some guidance in selecting the correct material. Only basic compounds are mentioned. A lot of special compounds are available, please ask the local ERIKS division for assistance.

#### Water and Steam Application

Most elastomers can be used for water applications up to 212°F (100°C). Water appears to be an innocuous fluid, people are often surprised to learn that it can bring problems if it is not sealed with the proper O-ring. The mere immersion in water has an adverse effect on the mechanical properties of rubber. After a long period of water immersion, many rubber compounds will swell. In a static application, this may be quite acceptable. Such a seal will not leak. And it can be replaced with a new one after disassembly. An advanced amount of swelling implies a larger volume and consequently more friction. Used as a long term dynamic seal, this gradual swelling of an O-ring in water can cause a slow but very annoying increase in friction. In tests, ethylene propylene rubber has virtually no swell. This material is recommended for O-rings for sealing against water and steam for temperatures up to 150°C (300°F).

#### ERIKS has compounds in:

EPDM PC 55914, HNBR, and AFLAS®.

In FFKM a number of Perfluoroelastomer compounds are available which exhibit perfect sealing properties in steam surroundings. Silicone (VMQ) can also be compounded in such a way that it can be used pressureless in a steam environment up to 250°C (480°F).

#### Note:

When sealing steam or hot water with ethylene propylene, it is important to remember that it will deteriorate when exposed to petroleum lubricants. When lubrication is required, silicone oil, glycerin, or ethylene glycol are suggested. When water changes into steam, the O-ring must maintain an effective seal as the temperature increases. This sometimes causes the rubber to become spongy as a consequence of which all sealing properties are lost. Some compounds, however, are steam resistant.

#### Food Application

Rubber in contact with foods must meet special requirements. There are a number of institutions who regulate the rules and tests. The main institutions are: FDA and NSF in the USA; KTW and BfR in Germany, WRAS in the UK, and KIWA in the Netherlands.

This book primarily discusses the FDA-program because it is the most demanding requirement.

#### Metal Detectable Compounds

Metal detectable seals are the latest advancement used for contamination detection and containment. These compounds can be widely used across a range of industries including Food and Beverage, Pharmaceutical and Dairy with the respective compliances according to FDA and 3A (Class 1). Broken products can be detected and rejected resulting in less product loss. The compounds are detectable by conventional metal detectable products with particle sizes as small as 2mm. So they are able to be used as part of a HACCP process. The temperature range of possible compounds is -60°C to +220°C.



### 6. Compound Selection - FDA



#### FDA Compliancy

##### General information about FDA

For many years ERIKS has had a leading role in the production and marketing of high quality seals. ERIKS has also developed a vast range of elastomeric compounds that are formulated to comply with the regulations issued by the 'United States Food and Drug Administration' (FDA). These regulations are stipulated in Title 21, Chapter 1, subchapter B, section 177.2600 of the 'Federal Food and Cosmetic Act'. These regulations define which rubber polymers and compound ingredients can be used in rubber articles, intended for repeated contact with food and preventing the use of dangerous substances that might cause cancer.

##### Types of FDA compliancy

Two important types (class 1 and class 2) of FDA compliance exist, depending on the percentage of carbon black that is added to the compound.

Class 1 : for aqueous and greasy media;

Class 2 : for aqueous media.

USP class 6 was especially developed for the pharmaceutical industry. ERIKS offers 5 compounds of this type of USP, all meeting very strict requirements.

#### Certification

ERIKS guarantees 'conformity' by:

- strict production methods,
- an FDA sticker is put on the packaging,
- a certificate of conformity can be obtained with every delivery.

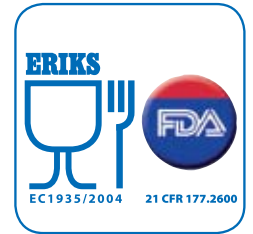

**In general ERIKS guarantees that the FDA materials are 'FDA compliant' which means they are composed with ingredients according the FDA regulations.**

#### Migration tests

Some compounds have been tested by independent laboratories. Rubber articles intended for repeated use in contact with aqueous food shall meet the following specifications: 'The food contact surface of the rubber article in the finished form in which it is to contact food, when extracted with distilled water at reflux 20 milligrams per square inch during the first 7 hours of extraction, not to exceed 1 milligram per square inch during the succeeding 2 hours of extraction'.

Rubber articles intended for repeated use in contact with fatty foods shall meet the following specifications: 'The food-contact surface of the rubber article in the finished form in which it is to contact food, when extracted with n-hexane at reflux temperature, shall yield total extractives not to exceed 175 milligrams per square inch during the first 78 hours of extraction, nor to exceed 4 milligrams per square inch during the succeeding 2 hours of extraction'.

### 6. Compound Selection - FDA - General Compounds



#### Vulc-O-rings FDA class 1

Vulc-O-rings are produced in small quantities. Inside diameter range from 30 mm up to 5.000 mm in the different cross section diameters from 1,78 up to 25 mm.

No chemical additive is added in the bonding of the core ends. Datasheets are available upon request.

Selecting the right elastomer is a balance of material and design.

All ERIKS compounds listed below are produced from listed ingredients. We distinguished the following grades:

#### High Performance O-rings with Certificates

Compound Number	Material ASTM D1418	Colour	Hardness IRHD±5	FDA 177.2600 aqueous & fatty foods	USP Class VI	KTW, DVGW, NSF, WRAS, ACS, W-270, KIWA	3A	EC 1935	ADI free	Temp. resistance °C
329303	Neoprene	black	75	X				X	X	-35/+100
366312 (*)	Nitrile-NBR	blue	60	X			X	X	X	-30/+120
366470	Nitrile-NBR	black	70	X			X	X	X	-30/+120
366302	Nitrile-NBR	black	75	X			X	X	X	-30/+120
366472	Nitrile-NBR	white	75	X				X	X	-30/+120
366480	Nitrile-NBR	black	80	X				X	X	-30/+120
366490	Nitrile-NBR	black	90	X				X	X	-30/+120
886972	HNBR	white	77	X				X	X	-30/+150
886172	HNBR	black	70	X				X		-30/+150
886214 (**)	HNBR	red	69	X				X	X	-30/+150
559260	EPDM	black	60	X				X		-40/+140
559311 (*)	EPDM	blue	67	X			X	X	X	-40/+140
55641	EPDM	black	70	X						-55/+150
559270	EPDM	black	70	X				X	X	-55/+150
559272	EPDM	white	70	X				X	X	-55/+150
559273	EPDM	black	70	X	X		X	X	X	-40/+150
55111	EPDM	black	70	X		X		X	X	-55/+150
559274	EPDM	white	70	X	X			X	X	-40/+150
559302	EPDM	black	70	X	X		X	X	X	-50/+150
559187	EPDM	black	75	X			X	X		-40/+140
559280	EPDM	black	80	X				X	X	-40/+140

(\*): metal detectable compounds

(\*\*): Bio-Hygienic®





### 6. Compound Selection - FDA - General Compounds

#### High Performance O-rings with Certificates

Compound Number	Material ASTM D1418	Colour	Hardness IRHD±5	FDA 177.2600 aqueous & fatty foods	USP Class VI	FDA 177.1550	3A	BfR	EC 1935	ADI free	Temp. resistance °C
514660	FKM	black	60	X					X	X	-15/+200
514670	FKM	black	70	X					X	X	-20/+200
514328	FKM	blue	70	X			X		X	X	-15/+204
514642	FKM	green	70	X					X	X	-20/+200
514672 (*)	FKM	white	70	X					X	X	-15/+200
514674	FKM	blue	70	X					X	X	-20/+200
514002	FKM	green	75	X					X	X	-20/+200
514010	FKM	white	75	X	X		X		X	X	-20/+200
514304	FKM	white	75	X			X		X	X	-20/+200
514172	FKM	black	75	X			X		X	X	-20/+200
514641	FKM	black	75	X					X	X	-20/+200
514682	FKM	white	80	X					X		-15/+200
514683	FKM	black	75	X					X		-15/+200
514312	FKM	black	75	X	X		X		X	X	-20/+204
Genuine Viton® A 514680	FKM	black	80	X					X	X	-20/+200
Teflex® Viton®	FKM/FEP/PFA	black	75	X	X	X			X	X	-20/+200
Genuine Viton® A 514690	FKM	black	90	X					X	X	-20/+200
Genuine Viton® A 514694	FKM	blue	90	X					X	X	-20/+200
Silicone 714742	VMQ	white	40	X					X	X	-60/+200
Silicone 714747	VMQ	transl.	40	X					X	X	-60/+200
Silicone 714748	VMQ	red	40	X					X	X	-60/+200
Silicone 714762	VMQ	white	60	X					X	X	-60/+200
Silicone 714767	VMQ	transl.	60	X	X				X	X	-60/+200
Silicone 714768	VMQ	red	60	X					X	X	-60/+200
Silicone 714217	VMQ	white	60	X	X		X	X	X	X	-60/+200
Silicone 714001	VMQ	transp.	70	X	X			X	X	X	-60/+200
Silicone 714330 (*)	VMQ	blue	69	X			X		X	X	-60/+220
Silicone 714002	VMQ	Transp.	75	X	X			X	X	X	-60/+200
Silicone 714206	VMQ	red	75	X					X	X	-60/+220
Silicone 714006	VMQ	red	75	X			X		X	X	-60/+220
Silicone 714782	VMQ	white	80	X					X	X	-60/+200
Silicone 714787	VMQ	transl.	80	X					X	X	-60/+200
Silicone 714788	VMQ	red	80	X					X	X	-60/+200
Teflex® Silicone	VMQ FEP/PFA	red	70	X	X	X			X	X	-60/+200
Kalrez® 6221	FFKM	white	70	X	X					X	260
Kalrez® 6230	FFKM	black	75	X	X					X	260

(\*): metal detectable compounds



### 6. Compound Selection Kalrez® - FDA

#### O-rings Kalrez® FDA Kalrez® Perfluoroelastomer Parts for Pharmaceutical and Food Handling Applications

Kalrez® parts made from compounds 6221 and 6230 provide superior chemical resistance and low contamination from extractables in pharmaceutical and food handling applications where FDA compliance is required. Compounds 6221 and 6230 are especially suited for Water For Injection (WFI) systems, Steam In Place (SIP) cleaning, and other critical systems.

#### Thermal Stability

Unlike other elastomeric seals made with FDA compliant elastomers, Kalrez® perfluoroelastomer parts are thermally stable up to 260°C, permitting use in applications such as Stage II Sterilization processes, where other elastomers lose their sealing capabilities.

#### Aggressive Water Resistance

In aggressive pharmaceutical and semiconductor processing environments, seal failure from excess swelling, embrittlement, or decomposition can cause unscheduled downtime or product contamination. Elastomeric materials that come in contact with highly pure and aggressive water (e.g. WFI) must be chosen with care in order to prolong seal life. The perfluoroelastomer compounds used in Kalrez® parts have been shown to have extremely low to non-detectable extractable levels in aggressive water systems. Because the perfluoroelastomer polymer in Kalrez® parts is fully saturated, it is also well suited for Ozonated Deionized Water service. Kalrez® parts also exhibit very low swell and loss of mechanical properties after repeated steam cycling.

#### General Chemical Resistance

The overall chemical resistance of EPDM's, silicone elastomers, and fluoroelastomers (FKM) is limited by their respective polymer structures. Kalrez® parts, on the other hand, offer the same universal chemical resistance as PTFE, but unlike PTFE, they have elastomeric properties, which help them maintain their sealing capabilities. Table 1 lists the chemical compatibility of Kalrez® perfluoroelastomer parts and other elastomers used as sealing materials in the pharmaceutical and food handling industries.

Table 1- Elastomer Chemical Compatibility \*

Chemical	Kalrez®	EPDM	VMQ	FKM
Acetic acid	A	A	A	B
Acetone	A	A	C	U
Citric acid	A	A	A	
Hydrogen peroxide	A	B	B	B
Isopropyl alcohol	A	A	A	
Metthyl ethyl ketone	A	A	U	U
Mineral oil	A	U	B	A
NaOH	A	A	B	B
Nitric acid	A	B	B	A
Sodium Hypochlorite	A	B	B	A
Soybean oil	A	C	A	A
Steam (<150°C)	A	A	C	U
Steam (>150°C)	A	C	U	U
Toluene	A	U	U	A
Xylene	A	U	U	A
Maximum Service Temp.	260°C	135°C	200°C	200°C

A = little or no effect ; B = slight swelling and/or loss of physical properties ; C = moderate to severe swelling and/or loss of physical properties/limited functionality ; U = not suitable or recommended.

\* Data has been drawn from DuPont Performance Elastomers tests and industry sources. Data is presented for use only as a general guide and should not be the basis of design decisions. Contact DuPont Performance Elastomers or ERIKS for further information.

Table 2- Typical Physical Properties \* \*

Compound	Kalrez® 6221	Kalrez® 6230
Colour	White	Black
Durometer hardness, Shore A, points±5	70	75
100% Modulus, psi (MPa)	1,050	1,020
Tensile strength at break <sup>(1)</sup> , psi (MPa)	2,200	2,400
Elongation at break <sup>(1)</sup> , %	150	170
Compression set <sup>(2)</sup> , 70h at 160°C	20	18

(1) ASTM D412, (500 mm/min) ; (2) ASTM D395 B, Size 214 O-rings

\*\* Typical physical properties should not be the basis of design decisions.

Contact DuPont Performance Elastomers for further information.

Ask about the special ERIKS brochure on High Purity Seals!

### 6. Compound Selection - FDA

#### O-rings Kalrez® FDA

Kalrez® perfluoroelastomer parts are not routinely tested using the USP testing protocol. Cured samples made only from compounds 6221 and 6230 have been tested in accordance with USP protocols and meet the requirements of a USP Class VI polymer. USP testing was done to support use of Kalrez® parts in pharmaceutical processing and food processing applications. While USP Class VI compliant materials are not required for pharmaceutical and food processing applications, many pharmaceutical and food processing customers, including customers seeking ISO-9000 certification, have requested compliance. Testing of any finished article that incorporates Kalrez® perfluoroelastomer parts is the responsibility of the manufacturer or seller of the finished article if certification that meets USP standards is required.

#### Note:

Please contact ERIKS engineers for determining the right Kalrez® O-ring for an application

#### Medical use

Caution: Do not use Kalrez® perfluoroelastomer parts in medical applications involving implantation in the human body or contact with internal body fluids or tissues. For other medical applications, see DuPont Performance Elastomers Medical Applications Policy, H-69237. DuPont Performance Elastomers will not sell or support products for implantation in the human body or contact with internal body fluids or tissues. DuPont Performance Elastomers makes no representation, promise, express warranty or implied warranty concerning the suitability of these materials for use in implantation in the human body or in contact with internal body fluids or tissues. The content of DuPont Performance Elastomers materials is not certified for implantats.

#### FDA and USP compliancy

The U.S. Food and Drug Administration (FDA) confirmed the compliance of Kalrez® 6221 and 6230 for repeated use in contact with food by Food Contact Notification (FCN) 000101. FCN 000101 was established through the FDA

Premarket Notification Process for food contact substances as described in section 409(h) of the Federal Food, Drug, and Cosmetic Act (21U.S.C. 348(h)) and is the primary method by which the FDA authorizes the use of food additives that are food contact substances. FCN 000101 requires materials to have extractable levels less than 0.2 mg/in<sup>2</sup>. Kalrez® 6221 and 6230 have also been tested in accordance with United States Pharmacopeia Class VI (USP Class VI) and met those requirements.

#### Proven suitability for food and pharma processing

DuPont Performance Elastomers welcomes the new legislation as an opportunity to reaffirm the suitability of Kalrez® 6221 and 6230 perfluoroelastomer parts for repeat use food contact applications. The FCN requires Kalrez® 6221 and 6230 to meet extractable levels not to exceed 0.2 milligrams per square inch. This provides further confirmation of the low risk of contamination from Kalrez® parts and the long term sealing solution for challenging food and pharmaceutical applications.

#### Statement of Compliance

Kalrez® parts made from compounds 6221 and 6230 meet the extractive requirements of 21 CFR 177.2600(E) and may be used for repeated use in compliance with the Food, Drug and Cosmetics Act and all applicable food additive regulations. Kalrez® parts made from compounds 6221 and 6230 have been tested in accordance with the United States Pharmacopeia Class VI (USP Class VI) testing protocol. Testing using the protocols cited above was performed by an external testing facility in compliance with 21 CFR, Part 58 Good Laboratory Practice for Nonclinical Laboratory Studies. 6221 and 6230 offer excellent steam cycling resistance and reduce extractables from sealing materials to trace levels.

**Kalrez® 6221 and 6230 have extractable levels comparable to PTFE**

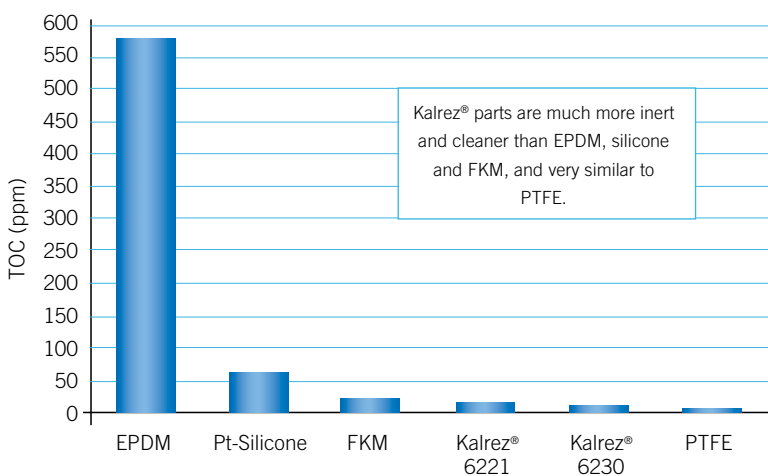

EPA method 415; TOC tests performed on 1" sanitary seals, immersed in 50 ml of sterile WFI at 100°C/24 hrs. The solution was then diluted to 100 ml and analyzed.

### 6. Compound Selection Potable Water - Certification

#### **KTW:**

KTW was adopted as a standard for drinking water. KTW controls the migration of harmful substances. A number of these constituents are subjected to limits. The O-rings are classified under the scope D2.

**See our data sheets gas/water on [www.o-ring.info](http://www.o-ring.info)**

#### **WRAS:**

WRAS controls the harmful constituents in rubber, like metal extraction and micro organisms.

**See our data sheets gas/water on [www.o-ring.info](http://www.o-ring.info)**

#### **NSF:**

**NSF = National Sanitation Foundation. This standard is mainly applied in the USA.**

ERIKS has a number of compounds with NSF compliance.

**See our data sheets gas/water on [www.o-ring.info](http://www.o-ring.info)**

#### **ACS:**

French homologation

#### **DVGW certificates**

ERIKS has several compounds for applications in the gas industry with DVGW-certificates.

The following table lists a summary of the DVGW norms.

We offer materials following DIN EN 549 and DIN EN 682.



### 6. Compound Selection

#### Vacuum Applications

The rate of flow of gases from the pressure side to the vacuum side of an O-ring seal depends to a great extent on how the seal is designed. Increased squeeze by reducing the groove dimensions reduces the leak rate dramatically.

Increased O-ring squeeze reduces permeability by increasing the length of the path the gas has to travel (width of O-ring) and decreasing the area available to the entry of the gas (groove depth). Increased squeeze can be realized with smaller grooves. Increasing squeeze also tends to force the rubber into any small irregularities in the mating metal surface, and thus prevents leakage around the O-ring. Therefore, surfaces against which an O-ring in a vacuum application must seal should have a surface roughness value smoother than usual. Surface finishes of 16 RMS are quite common.

Lubricating the O-ring with a high vacuum grease also reduces the leakage. The vacuum grease aids the seal by filling the microscopic pits and grooves, thus reducing leakage around the O-ring.

Although a very high squeeze is necessary to reduce leakage to an absolute minimum in an O-ring seal, this kind of design may require heavy construction. When a shallow gland is desirable, it must be wide enough to receive the full O-ring volume, also at higher operating temperatures.

The vacuum level denotes the degree of vacuum evidenced by its pressure in torr (or mm. Hg).

Rough vacuum 760 torr to 1 Torr, Medium vacuum 1 torr to  $10^{-3}$  Torr, High vacuum  $10^{-3}$  torr to  $10^{-6}$  Torr, Very high vacuum  $10^{-6}$  torr to  $10^{-9}$  Torr, Ultra high vacuum below  $10^{-9}$  Torr.

For effective vacuum sealing the compound must possess certain properties: low compression set, low permeability to gas, and it should contain few softeners. The best choice is Butyl, but this is very unusual as O-ring compound, followed by a fluoroelastomer.

Extracted plasticizers can leave a film on the instruments.

In static vacuum applications it is recommended to design for a squeeze of the O-ring of at least 25-30% to absorb the irregularities of the metal surface.

It is of great importance that a compound is used with the lowest possible compression set, because temperature fluctuations may impair the sealing properties even further.

ERIKS has compounds that are well suited for vacuum applications:

#### Vacuum Applications

Polymer type	Loss of Weight
Butyl	0,18
CR	0,13
EPDM	0,76
Fluorsilicone	0,28
NBR	1,06
Polyurethane	1,29
Silicon	0,31
FKM	0,07

Loss of weight at  $10^{-6}$  Torr after 2 weeks at 23°C / 73°F.

## 6. Compound Selection

### Degassing

When using O-rings in high vacuum, permeability and degassing of O-rings play an important role and therefore these aspects have to be taken into account. The lower the permeability of the rubber, the easier it is to maintain the vacuum.

Some rubber compounds still contain relatively volatile substances after vulcanisation, which egress from the compound in particular high vacuum applications. Degassing is the loss of volatile elastomeric compounds in vacuum application. This results in some volume loss of the seal material which will lead to seal failure.

The results are:

Vacuum seals are improved by gradual changes to system pressure, the installation of elastomers with greater hardness and higher density, and lowering the system temperature which will result in lower degassing.

For this reason Fluoroelastomers and Perfluorinated elastomers are often used in vacuum applications.

Vacuum applications in combination with service requirements such as high temperature, radiation resistance, and exposure to combinations of fluid media will require careful analysis to select the proper O-ring.

### Contact with plastics

O-rings are more and more being used as a seal in contact with plastics. The problem being faced when the rubber comes in contact with plastics, is the migration of softeners or other "process aids" from the rubber into the plastic. The offending ingredients are usually the ester plasticizers used in some rubber compounds. Additives in the plastic can also migrate into the O-ring, causing substantial change of properties. After the migration of softeners into the plastic, "surface cracking" may arise, resulting in a deterioration of tensile strength. Not all plastics are susceptible to this phenomenon to the same extent. Plastics which are the most susceptible to these softeners are: ABS, Noryl, and Polycarbonate.

Tests have shown that EPDM peroxide cured, FKMs, neoprene, and some silicones are the best choice.

ERIKS also has an EPDM compound 55914PC that will work well.

### High Purity Compounds

In many modern industries high-purity O-rings are used more and more for an optimal progress of the production process. Fluoroelastomer parts are widely used in wet chemical and plasma environments in the fabrication of integrated circuits. Traditional seals often contain carbon black as a reinforcing filler. Many speciality fluoroelastomer compounds contain inorganic or metallic fillers to achieve improved seal performance in aggressive environments. Use of these metal fillers, while beneficial to seal life, can increase particle generation and extractable contaminants.

O-rings made with high purity fluoroelastomers and perfluoroelastomers are designed to meet the demanding contamination needs of the semiconductor industry. From applications in lithography to etching and cleaning, O-rings manufactured with high purity fluoroelastomers offer unmatched extractable contamination performance versus traditional fluoroelastomer O-rings.

Thanks to specific production, compounding, inspection, and ambient factors, several levels of purity are available.

**Consult our website for actual information:**

**[www.o-ring.info](http://www.o-ring.info)**

### Note:

- Clean Room packaging on demand
- ERIKS can deliver high-purity compounds in silicone, Viton®, and Kalrez® for the semicon industry.

### 6. Compound Selection

#### Permeability / Contact with Gases

All rubber compounds are more or less permeable to gas. The rate of permeability to gas of the various compounds varies. Permeability is the tendency of a gas to pass or diffuse through the elastomer. This should not be confused with leakage, which is the tendency of a medium to go around the seal. All elastomers are permeable to some extent allowing air or other gases under pressure or volatile liquids, to penetrate into the seal material and gradually escape on the low pressure side. Permeability may be of prime importance in vacuum service and some pneumatic applications. Permeability is increased as temperatures rise and is decreased by compression of the sealing material. The permeability rate of various gases through different rubber materials varies in an unpredictable way. Even the same basic compounds show large differences. Several gases give different values for the same compound. Permeability is also affected by application parameters such as cross section, pressure, and temperature. It is typical that harder compounds, generally containing more carbon black, exhibit better values. When using NBR a higher ACN percentage is more advantageous.

Laboratory tests have demonstrated that permeability of lubricated O-rings is lower than dry O-rings. These test also show that more strongly squeezed O-rings show lower permeability. In fact, the permeability of a given base polymer will vary according to the proportions of the copolymer. The best choices are Butyl, Fluoroelastomer (FKM 51414), and Nitrile with a high percentage of ACN. Butyl is very unusual as an O-ring compound.

The following list indicates other compounds ranging from the lowest permeability to the highest:

- AU: Polyurethane
- NBR: Nitrile
- FKM: Fluorocarbons
- FFKM: Perfluorinated Elastomers
- EPDM: Ethylene Propylene
- SBR: Styrene/Butadiène
- NR : Natural Rubber

Silicone and Fluorosilicones have even higher gas permeability. Ask for information about gas permeability rates of other ERIKS compounds.

#### Gas permeability

The following table gives the gas permeability coefficient for different media and compounds:

Gas permeability								
Gas permeability coefficient 10 <sup>-17</sup> m <sup>2</sup> / (s x Pa)	IIR	AU	NBR (38% ACN)	NBR (33% ACN)	NBR (28% ACN)	CR	NR	VMQ
Air 60°C / 140°F	2,0	2,5	2,5	3,5	7,5	6,0	25,0	330
Air 80°C / 175°F	5,0	7,0	5,5	7,0	21,0	12,0	40,0	410
Nitrogen 60°C / 140°F	1,5	2,5	1,0	2,0	4,0	4,5	18,0	280
Nitrogen 80°C / 175°F	3,5	5,5	2,5	5,5	7,0	8,0	33,0	360
CO <sub>2</sub> 60°C / 140°F	13	26	30	56	58	58	160	950
CO <sub>2</sub> 80°C / 175°F	29	73	48	63	97	71	210	1500



### 6. Compound Selection

#### High Pressure Gases / Explosive Decompression

In high pressure applications above 1500 psi (100 bar), gases tend to fill the microscopic small pores in the rubber. When using O-rings in high gas (or volatile liquid) pressures or sudden pressure drops, the permeability of elastomers has to be considered.

If gas under high pressure has the opportunity to penetrate to a sufficient degree into the elastomer, this penetrated gas (or volatile liquid) will expand when a sudden pressure drop occurs and will want to leave the elastomer. The greater the pressure, the larger the amount of gas forced into the rubber. When the pressure suddenly drops, the gas expands in the O-ring and will find its way into the atmosphere. The gas may escape harmlessly into the atmosphere, or it may form blisters on the surface. Small cracks deep into the O-ring will consequently develop. Some of these may rupture, leaving cracks or pits and will damage the seal. This phenomenon is called Explosive Decompression.

Generally it is assumed that this phenomenon can occur in cases of pressure drops greater than approx. 400 psi (ca. 30 bar or 3 MPa.). Variables to consider are the gas, pressure, temperature, and the rubber compound. Generally carbon dioxide (CO<sub>2</sub>) causes more problems than nitrogen does. Improvement can be realized in gradual reduction of the pressure and use of rubber with a higher hardness and a higher density. Resistance can be improved by increasing hardness up to 90-95 Shore A. Another method is to decrease the cross section of the O-ring, though this method is not always successful. Nitrile and Fluoroelastomer are the best standard materials for this application.

#### ERIKS has compounds in:

Aflas® for applications with gas and steam.  
FKM 514162 in 94 IRHD, special for oil and gas industry.  
Only by using highly selected rubber compounds and by carefully mixing all ingredients, an "explosive decompression resistant" material can be achieved. Naturally all these compounds are also extrusion resistant.

#### Offshore Applications

In offshore conditions O-rings are exposed to extreme pressures, temperatures, and aggressive media.  
The critical circumstances become even greater by very aggressive oil additives, varying temperatures, gap extrusion, and explosive decompression. Under such conditions only special compounds will be acceptable.  
ERIKS compounds:  
NBR-95, extremely extrusion resistant, tested by the American Petroleum Institute.

AFLAS-90, High molecular Aflas® with increased extrusion resistance and very good compression set. Ideally suited for applications with amines and strong lyes. Can be used up to 200°C (390°F).

HNBR-XNBR 90, a blend of HNBR and XNBR 90 IRHD, ensuring an extreme wear resistance combined with a very high extrusion resistance. Can be used to 150°C (300°F). Also available in 80 IRHD.

#### Compatibility of elastomers with Mineral Based Oils

A well known rapid method for material selection for O-ring applications in mineral oils is the selection based on the aniline point of the oil. The ASTM D 471 test reference oils cover a range of aniline points found in lubricating oils.  
Test Oil ASTM No.1, has a high aniline point 124°C (225°F) and causes slight swelling;  
Test Oil IRM 902, has a medium aniline point 93°C (200°F) and causes intermediate swelling;  
Test Oil IRM 903, has a low aniline point 70°C (157°F) and causes high or extreme swelling of O-ring compounds.

Note: The aniline point of a petroleum oil appears to characterize the swelling action of that oil on rubber vulcanisates. In general, the lower the aniline point, the more severe the swelling action caused by the oil. In static O-ring applications, 20% volume swell may be acceptable, in dynamic applications volume swell may need to be less than 10%.

Any other commercial oil with the same or similar aniline point can be expected to have a similar effect on a O-ring as the corresponding ASTM test oil. However, it has been found that the aniline point method is not always reliable. Some commercial oils, having the same aniline point, can differ significantly because they contain different additives. **It is recommended to conduct compatibility tests on materials in question in the oil that will be used in the application.**

B-test fluids make an extraction of the low molecular softeners of the rubber compound. The more softeners in a compound the more an O-ring hardens and shrinks in an application. Shrinking in O-ring applications is not acceptable. Leakage can be the result.

A popular B-test fluid is a mixture of 42.25% toluene, 25.35% iso-octane, 12.7% di-iso- butylene, 4.3% ethanol, 15% methanol and 0.5% of water.



### 6. Compound Selection

#### Mineral Oils, Hydraulic Fluids

These oils are most frequently used in industry. Their greatest disadvantage is their toxic character and incombustibility. These products are not exactly defined, but they are a mixture of various hydrocarbons. The following guidelines can be given for the several kinds of rubber.

General: Almost all hydraulic fluids contain active additives which can attack the elastomers, certainly at high temperatures. NBR is the workhorse of these fluids. The higher the ACN content in the NBR, the better the resistance. Standard NBR types tend to harden from 110°C (230°F) and higher when additional cross linkage occurs.

#### ERIKS compounds for hydraulic fluids

- NBR: All types can be used.  
Please request a list of available types.
- HNBR: Can be used up to 150°C (300°F), especially compounds which are peroxide cured.
- Neoprene: Shows strong swelling in paraffin oils, as a result of which there is hardly any demand for this rubber.
- FKM: Can generally be used up to 200°C (400°F). Resists many additives, with the exception of certain amines. These amines may cause the rubber to harden quickly. That is why peroxide cured FKM types (FKM GF type) or FFKM are applied in these cases. Also AFLAS® has excellent resistance at very high pressures.
- Silicone: Silicone O-rings can be applied in highly viscous oils only, but are very sensitive to active additives.
- Fluorosilicone: very good up to 175°C (350°F), can also be used till -60°C (-76°F).
- ACM: Generally good resistance to oils up to 150°C (300°F).
- ECO: Epichlorhydrin has good petroleum oil resistance and a wide temperature range -51°C (-60°F) to +150°C (+300°F).
- Polyurethane: Very high resistance, though very sensitive to hydrolysis.

#### Synthetic Oils, Hydraulic Fluids

These fluids have some advantages over mineral oils.

They exhibit better thermal stability, a wider range of application temperature, and lower volatility. On the other hand, prices are higher. A detailed listing of fluids would be too extensive.

Following are a listing of general rules on fluid resistance:

The polar elastomers like NBR, FKM, ACM, HNBR, ECO, and AU have good resistance.

Resistance to hydraulic fluids cannot always be predicted, because the additives often play the major role in chemical attack. As in most cases these additives are not always known, it is always recommend to perform a test to be certain.

#### HFA and HFB Fluids

These fire resistant oils are more aggressive. Specially formulated NBRs should provide an acceptable level of swelling.

ERIKS has several compounds in NBR.

If a minimum amount of swelling is required, fluorocarbons such as FKM 51414 should be used. The best possible option is the FKM 514075 compound thanks to its minimal compression set. Standard polyurethane is limited to 50°C (122°F) due to its sensitivity to hydrolysis.

#### Vegetable Oils

These are oils made from seeds, fruits, or plants, like olive oil, palm oil, and rape seed oil. They have the advantage of being biodegradable and non-toxic. Because recent advancements in hydraulic fluids have made them biodegradable, hydraulic fluids have become more and more popular.

They have, however, a low temperature resistance 80°C (176°F). Therefore, high temperature resistant elastomers are not necessary.

In most cases NBR will perform well, though NBR compounds containing a lot of plasticizers may sometimes begin to swell. The use of polyurethane is limited, though short-time use will only show little swelling. Degradation will mostly occur, certainly after hydrolysis develops.

EPDM and butyl exhibit good chemical resistance, though swelling may occur up to 40%. They can therefore only be used in static applications.

ERIKS has compounds in NBR 70 36624 (70 IRHD); NBR 90 47702 (90 IRHD); also special NBR compounds for FDA, WRC, and KTW applications.

#### Note:

This information on resistance is for reference only. The end-user is responsible for ensuring compatibility.

## 6. Compound Selection

### Hydraulic and Transmission Oils and ACN content

High ACN content with a low plasticizer level provides excellent resistance to petroleum oils. Low ACN content with high plasticizer level gives better flexibility at lower temperatures. A peroxide-cure provides the best compression set resistance at elevated temperatures. These properties are important for use in hydraulic applications.

ERIKS has several NBR compounds with high ACN content for the extreme demands of heavy equipment, for automatic transmission fluid (ATF), crude oil, as well as NBR with low ACN content for flexibility at very low temperatures.

### Silicone Fluids

Silicone fluids are chemically very stable. Referring to fluid compatibility tables, all types of seal elastomers, except silicone rubber, may be used for silicone oils and greases. There are some exceptions; however, silicone fluids have a tendency to remove plasticizers from elastomer compounds, causing them to shrink. The effect is most severe with low viscosity fluids and high temperature applications. Because of this, military nitrile compounds and any other nitriles with a low temperature limit below -40°F (-40°C) should not be used to seal silicone fluids, because low temperature nitriles must contain plasticizers.

Other compounds should be tested before being used to be certain they will not shrink more than one or two percent.

Silicone rubber has a poor chemical compatibility rating in contact with silicone fluids. This is because silicone rubber tends to absorb silicone fluids, resulting in swelling and softening of the O-ring. Occasionally, however, it is desirable to seal a silicone fluid with a silicone rubber O-ring. This combination is generally acceptable if the viscosity of the silicone fluid is 100,000 centistokes or more, and if the maximum temperature will not exceed 150°C (300°F).

**Summary of the resistance for mineral and biological degradable oils**

Mineral oils	Elastomer to use
Type:	
H	NBR, FKM, HNBR, AU
H-L	NBR, FKM, HNBR, AU
H-LP	NBR, FKM, HNBR, AU
H-LPD	NBR, FKM, HNBR, AU
H-V	NBR, FKM, HNBR, AU
Waterbased oils	Elastomer to use
Type:	
HFA (>80% water)	-5° +55°C - NBR, FKM, AU
HFB (40% water)	-5° +60°C - NBR, FKM, AU
HFC (35% water)	-20° + 60°C - NBR
HFD-R	-20° + 150°C - EPDM (aeronotique)
HFD-S	-20° + 150°C - FKM
Biological oils	Elastomer to use
Type:	
HETG	for agriculture up to 80°C: AU, NBR, HNBR
HEPG	for protected waterareas up to: 80°C AU, NBR, ANBR, FKM* +80°C: HNBR, FKM* (*only peroxide cured FKM's)
HEES	up to 80°C: AU, NBR, HNBR, FKM +80°C: HNBR, FKM* (*only peroxide cured FKM's)

## 6. Compound Selection

### Contact with Fuels

Fuels are very complex fluids when considering elastomers. Fuels are a blend of aromatic and aliphatic hydrocarbons with the addition of alcohol. It is always recommended to do tests, though Fluoroelastomer, Epichlorhydrin (ECO) and special NBR compounds are most generally used.

For a survey of the Fluoroelastomer compounds please refer to the general Fluoroelastomer brochure which will be sent upon request.

The UL (Underwriters Laboratories, Inc.) A Not For Profit Organization, sponsored by the American Insurance Association, tests and lists many safe electrical and fire protection devices and equipment for use with hazardous liquids and chemicals. For many years they have tested and reexamined elastomer compounds, as being suitable for use with gasoline, naphta, kerosene, liquified petroleum gases, and fuel oils. UL listed O-ring compounds may be used with assurance for gasoline and LPG stations valves, pumps and metering devices, LPG gas bottles, valves, and other types of equipment requiring reliable seals.

### Fuels for Automobile Engines

There are several automotive fuels on the market; leaded and unleaded gasoline with and without MTBE, each type of which can vary in composition and gasohol content. Gasohol is a mixture of gasoline with 10 to 20 percent alcohol. The alcohol may be either ethyl (also called ethanol or grain alcohol) or methyl (methanol or wood alcohol).

The best rubber compound to use depends not only on the fuel itself, but also on the temperature range anticipated and the type of usage, i.e. whether in a static or a dynamic application. In automotive fuel applications, extremely high temperatures are not anticipated, but in northern climates, temperatures as low as -40°C (-40°F) or even -55°C (-65°F) are sometimes encountered.

Most of the compounds recommended for use in fuel have poor low temperature capability in air, but in a fluid that swells them, low temperature capability improves.

### Fuels for Aviation Systems

Aviation fuel systems are low temperature applications. NBR compounds must have good low temperature flexibility, generally low ACN, and higher plasticizer content. Fluorosilicone is also used in aircraft fuel systems and is resistant down to -80°C (-112°F).

### Extreme Temperatures

When air or other gases must be contained at temperatures below -55°C (-65°F), the recommended low temperature limit for most silicone rubbers, special compounds must be used. If the permeability rate of silicone rubbers is too high for the application, bear in mind that the rate decreases as temperature goes down, then an alternative compound must be selected. For applications requiring moderately high temperatures as well as low, it is feasible to use two O-rings, a silicone rubber O-ring to maintain the seal at low temperature plus a fluorocarbon to reduce permeability when the seal is warmer. If a low temperature O-ring must have resistance to a fluid that attacks silicone rubber, then an O-ring in fluorsilicone rubber is recommended. This material has excellent resistance to a wide range of fluids, is usable up to 177°C (350°F) or higher in many applications, and will often seal at temperatures as low as -73°C (-100°F).

Other compounds will often seal at temperatures below their normal low temperature limit by increasing the squeeze. This procedure, however, is generally limited to static face type designs. A heavy squeeze makes a radial seal difficult to assemble.

### 6. Compound Selection

#### Extremely High Temperatures

Extremely high temperatures cause physical and/or chemical attack which may lead to seal failure. Due to extreme heat energy the O-ring will start swelling in the groove, which increases friction at dynamic applications. In many cases the O-ring hardens considerably and the compression set value is different than at lower temperatures. At high temperatures thermoplastic materials may even start flowing so that leakage occurs.

Best choice: a series of special compounds have been developed to provide optimal sealing performance under these conditions. These compounds are: AFLAS®, Fluoroelastomers, Perfluoroelastomers, Silicone, or Fluorosilicone. PTFE, as a thermoplastic material, can be the best choice if elasticity is not required. Perfluoroelastomers can withstand continuous temperatures of 326°C (620°F). Standard compounds NBR and EPDM can be formulated such that a better temperature resistance is achieved. For example, the ERIKS EPDM PC 55914 provides an exceptionally high temperature resistance for EP-type elastomers.

Certain fluoropolymers degrade above 300°C and may release harmful gases if the temperature continues to rise. Please also note that high temperatures will noticeably deteriorate many properties of the compound: permeability to gas, tensile strength, and compression set.

#### ERIKS has compounds:

- up to 200°C (390°F) all fluoropolymers FKM, Teflex-FKM, Teflex-Silicon;
- up to 220°C (430°F) FFKM, Silicone 714177, Fluorosilicones FS 60, FS 70, FS 75, FS 80;
- up to 280°C (540°F) FFKM and special Silicone compounds;
- up to 327°C (620°F) FFKM.

Please be also aware that the temperature resistance greatly depends on the sealing time and chemical environment. Consult ERIKS for assistance in selecting other compounds or consult the material data sheets.

#### Extremely Low Temperatures

Low temperatures reduce molecular activity causing elastomeric compounds to appear harder. At extreme low temperatures elastomers achieve a glass like state and become very brittle, but may still seal and often resume their normal flexibility without harm when warmed. This condition is reversible as temperatures rise. The temperature at which this glass like state occurs can be determined by testing.

The standards for this testing are recorded in ISO 812, ASTM D2137, BS 90 part 25, and ASTM D746.

Extreme cold makes the O-ring shrink in the groove which causes the seal to contract which may cause the seal to leak. If the temperature falls even further, the O-ring will continue to shrink and become brittle - it will be able to be broken upon impact.

The best choice may be Silicone which remains flexible in temperatures down to -50°C (-58°F). Please note that silicone has a very poor chemical resistance and a high permeability to gas. Fluorosilicone is the solution when fuels or oils are involved. It is generally used in aircraft fuel systems and is resistant down to -80°C (-112°F).

PTFE can be used to -170°C (-275°F) but does not have any elasticity properties. It will also start flowing under pressure very quickly (cold flow). PTFE with fillers can reduce this problem noticeably. The metal spring-loaded seal can be useful. Spring-loaded PTFE seals will provide good sealing performance under these conditions. Please ask for the ERIKS technical brochures. Also Teflex, FEP encapsulated

O-rings combine a low temperature resistance (Silicone) with a very good chemical resistance. The low temperature resistance can also be increased by applying more squeeze on the O-ring. This can of course only be done when using static seals.

#### ERIKS has compounds in:

- FKM and NBR to -40°C (-40°F);
- EPDM 55914 and EPDM 55914 PC to -50°C (-56°F);
- Silicone 714177 to -60°C (-76°F);
- Special Fluorosilicone for low temperatures to -90°C (-130°F);
- Metal spring activated FEP O-ring to -200°C (-325°F)

The TR-10 value is a good indicator of the low temperature limit of a dynamic seal or a static seal exposed to pulsating pressure. In a static steady pressure application, an O-ring will generally function to a temperature approximately 8°C or (15°F) lower than the TR-10 temperature. Please note that the TR-10 minimum temperatures as mentioned in the ERIKS data sheets are test values only. Experience has taught that the service temperature is about 10°C (18°F) lower than the TR-10 values indicated.

#### Note:

See also page 39 for Viton® information.

### 6. Compound Selection

#### Coefficient of Friction

Friction causes wear, and seals do not form an exception to this rule. The level of wear is determined by 4 factors: lubricating properties of the medium, surface roughness of the metal, pressure and temperature, and the characteristics of the elastomer.

Generally, breakout friction is many times greater than running friction, but this varies with several factors, primarily the hardness of the O-ring. When only the hardness is changed, an increase will raise breakout friction and a decrease will lower breakout friction.

For special applications where external lubrication is impossible there are several compounds having self-contained lubricants.

This internal lubrication is the incorporation of a friction reducing ingredient into the rubber formula. Since this changes the formula, internally lubricated materials are assigned special compound numbers. Internal lubricants may be such materials as graphite, molybdenum disulfide, powdered PTFE or, more commonly, an organic lubricant. This lubricant migrates through the O-ring and gradually congregates on the surface.

There also exist processes which can modify the surface of an NBR O-ring. The coefficient of friction decreases by up to 50%. The surface is not faced to ensure that all rubber properties are kept. This procedure is also very eco-friendly and can also be applied for drinking water applications.

The so-called AF treatment for Viton®, EPDM, and silicone provides a surface oxidation which builds up an oily film on the rubber. Here too, when the rubber comes in contact with oil, the coefficient of friction can be reduced up to 50%.

#### Abrasion and Wear Resistance

Abrasion resistance is a general term which indicates the relative wear of a compound. It concerns scraping or rubbing of the O-ring surface and is therefore of importance for O-rings used as dynamic seals. This is a very complex problem and cannot be deeply discussed in this edition. Please consult the local ERIKS representative.

The ideal contact surfaces should be 8 to 16 RMS without longitudinal or circumferential scratches.

Best surfaces are honed, burnished, or hard chromeplated. Finishes of dynamic contacting surfaces have a lot to do with the life of the O-ring seals. Appropriate surface finishes are important. Limits of maximum roughness for glands are given because rougher finishes will cause excessive wear. Finer finishes reduce lubrication to the O-ring and may result in stick slipping and irregular wear. Surface roughness values less than 5 micro inches ( $R_a = 0,15 \mu\text{m}$ ) are not recommended for dynamic O-ring seals. The surface must be rough enough to hold small amounts of oil. Finishes below 5 RMS wipe too clean for good moving seal life.

Only some of the elastomers are recommended for O-ring service where moving parts actually contact the O-ring. It is of interest that harder compounds, up to 85 IRHD, are normally more resistant to abrasion than softer compounds. Of course, abrasion resistance must be considered in the light of other requirements such as surface finish and lubrication. The best wear resistance is offered by PUR (Polyurethane) and special XNBR compounds which have proved their value in the offshore world.

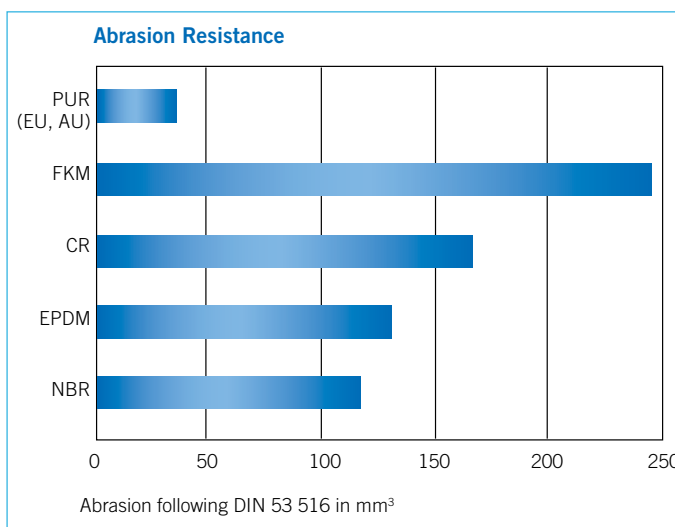

### 6. Compound Selection

#### Contact with Ozone

Ozone is becoming an increasingly inconvenient factor when using O-rings. The large concentrations which develop in summer deteriorate certain elastomers very quickly. Many elastomers like Viton®, silicone, neoprene and EPDM are very suitable for high ozone concentrations. However NBR, the elastomer most commonly being used, is highly sensitive to ozone. At limited concentrations of 50 ppm, little cracks, perpendicular to the direction of stretch, occur in NBR seals. There are a number of possibilities to prevent this:

- Use Viton® because of broad stockrange.
- Use HNBR.
- Use a compound such as NBR/PVC. The lower compression set of NBR/PVC versus NBR should, however, be taken into account.
- Use neoprene CR 32906.
- Use different compounds, (mostly at higher prices e.g. FKM).
- Use ozone resistant NBR.
- Use white compounds for high ozone.

#### Radiation

One of the most important properties of an elastomer, used as an O-ring, is its resistance to compression set. With exposure to gamma radiation, the compression set is most severely effected (of radiation types, gamma radiation has the worst effect on elastomeric materials). After experiencing 108 rads, all elastomers will take over 85% compression set, enough loss of memory that leakage can be expected. At 107 rads, there are big differences between compounds, while at 106 rads, the effects on all compounds are minor.

Therefore in the range of 107 rads an O-ring compound must be selected with care, while at higher levels they should not be considered. At lower levels, factors other than radiation will be more significant. It is therefore important to test a seal in conditions similar to those it will encounter in service. Ask Eriks for data on radiation resistance of O-ring compounds.

#### Electrical Conductivity / Shielding

Elastomers can range from electrically insulating to conductive. This particularly depends on the additives which are added to the elastomers. Specifically:

- insulating: more than  $10^9$  Ohm x cm (almost all rubbers)
- limited conductivity:  $10^5$  to  $10^9$  Ohm x cm (neoprene)
- conductive: lower than  $10^5$  Ohm x cm (special compounds)

It is often essential to shield electronic devices from electromagnetic interference (EMI) to prevent electromagnetic energy from escaping or to ground electronic devices. Conductive elastomers have been developed to provide hermetic sealing in combination with shielding and grounding. These materials can be fabricated into O-rings, Quad-Rings®/X-Rings, molded shapes, sheet stock and die-cuts.

#### Electrical Properties

Polymer	Specific Resistance (Ohm)		Resistivity	
	from	up to	from	up to
NBR	$10^4$	$10^{10}$	15	17
FKM	$10^{10}$	$10^{14}$	20	35
MVQ	$10^{15}$	$10^{16}$	20	40
EPDM	$10^6$	$10^{16}$	10	25
CR	$10^2$	$10^{13}$	5	15
FFKM	$10^{17}$	$5 \times 10^{17}$	16	18
MVQ	0,002	5	-	-
MFQ	0,004	0,1	-	-
EPDM	0,006	10	-	-
FKM	0,006	0,006	-	-

### 6. Compound Selection

#### Colored O-rings

Color compounds offer identification for positive assembly and traceability during and after service. Generally O-rings are black (except silicone), because most of them are filled with carbon black. Carbon black gives the best mechanical sealing properties. In certain cases, however, white additives, like titanium dioxide, can also be used. Green and brown are often used for Viton®, and for silicone red, iron oxide is generally known. In principle any color can be manufactured subject to sufficient quantities ordered.

Presently also fully transparent silicone O-rings can be made. O-rings can also be identified by applying a colored dot on the surface which may ease in differentiating products.

A colored dot can also be applied during the vulcanization process. This dot cannot be removed. The dot is of the same quality as the O-ring and no negative reactions will occur.

Another technique to recognize the rubber material is used by certain FKM Viton® O-rings. By adding a special substance, a tracer, the O-ring will be fluorescent under UV-light which makes identification of the O-ring easier.

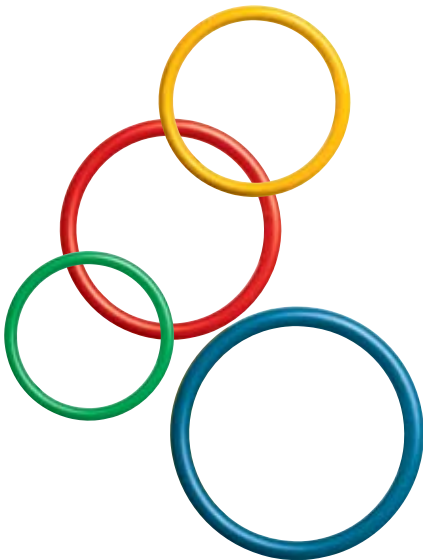

#### O-rings in drive belt applications

O-rings are frequently used for drive belts in relatively low power applications on audio visual equipment.

O-rings are designed to maintain a seal while being compressed, whereas a drive belt must maintain its shape and dimensions against a constant stretching load. Therefore, the material of the O-ring used for a drive belt must provide resistance in a number of areas:

- Resistance to creep, the tendency of rubber to slowly stretch or relax.
- Resistance to severe flex, common at high rotational speed.
- Resistance to the abrasion that occurs as the belt travels over the pulleys and sprockets at high speed.

Critical environmental factors may include the presence of ozone, extreme operating temperatures, and other factors.

For optimum results the following are recommended:

- Limit the O-ring stretch to 10-15% of the outside diameter.
- Semi-circular grooves should be half rounded and have a radius equal to the O-ring cross section.
- The diameter of the sheave should be larger than 4 times the O-ring cross section.
- Abrasion resistance is important.

Most O-rings used in drive belt applications are made from Ethylene Propylene or Polyurethane. Polyurethane can exhibit good service life when stretched 20-25%. Depending on the application various elastomeric compounds may also be used effectively. Please contact an ERIKS representative for additional information.

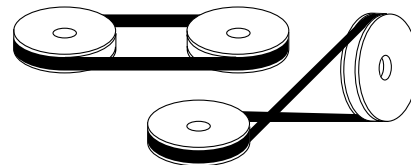



### 6. Compound Selection

#### Linear Expansions

Elastomers have different expansion rates than plastics or steel. So the design of the grooves have to be adapted to that.

#### Thermal Expansion

Material	Thermal Stability	x10 <sup>-5</sup> / °C
FKM	200°C / 392°F	16
NBR	120°C / 250°F	23
VMQ	230°C / 450°F	59-79
FFKM	300°C / 570°F	23
EPDM	150°C / 300°F	16
Stainless	-	1.04
Aluminium	-	1.3
TEFLON	230°C / 450°F	5-8
KEL-F	280°C / 540°F	4-7
Polyimide	275°C / 530°F	5



#### Gas Permeability

The following table gives the gas permeability coefficient for different media and compounds.

#### Gas permeability

Gas permeability coefficient 10 <sup>-17</sup> m <sup>2</sup> / (s x Pa)	IIR	AU	NBR (38% ACN)	NBR (33% ACN)	NBR (28% ACN)	CR	NR	VMQ
Air 60°C / 14°F	2,0	2,5	2,5	3,5	7,5	6,0	25,0	330
Air 80°C / 175°F	5,0	7,0	5,5	7,0	21,0	12,0	40,0	410
Nitrogen 60°C / 140°F	1,5	2,5	1,0	2,0	4,0	4,5	18,0	280
Nitrogen 80°C / 175°F	3,5	5,5	2,5	5,5	7,0	8,0	33,0	360
CO <sub>2</sub> 60°C / 140°F	13	26	30	56	58	58	160	950
CO <sub>2</sub> 80°C / 175°F	29	73	48	63	97	71	210	1500



### 6. Compound Selection- SurfaPlus

#### SurfaPlus Modification

SurfaPlus surface treatment is the solution for the high frictional resistance of elastomers.

Rubber (also classified as an elastomer) plays a leading role in the fascinating world of sealing. And with good reason - this material has a large number of excellent characteristics. Rubber is flexible and resilient, strong, easy to manufacture and to use, resistant to a wide range of media and temperatures and attractively priced.

One disadvantage is that the frictional resistance of rubber, particularly in dynamic applications, can lead to wear and the generation of (excessively) high frictional heat at the seal. Also the sticking of O-rings in the packaging causes a lot of problems in automatic assembly. The introduction of ERIKS new 'SurfaPlus' surface treatment programme for rubber products relegates these problems to the past.

This brochure introduces the most common surface treatment products for rubber products. Each is capable of making a significant contribution to the improved performance of your seals. We will also inform you about the early stages of a new development and explain that specific targets can be attained via the use of various treatments. Thus it is of great importance that the surface treatment chosen for your specific application is tested in advance. Contact your nearest ERIKS branch for advice without obligation about an ERIKS 'SurfaPlus' surface treatment for rubber products. Our specialists will be happy to explain all the various options. Material specifications are available for all the surface treatments.

The extensive ERIKS 'SurfaPlus' surface treatment programme for rubber products offers you countless ways of improving your seals for specific applications. We will explain the most frequently used treatments here.

#### 1. Lowering frictional resistance in dynamic applications

We use a spray applied PTFE based coating to lower the frictional resistance of rubber. The use of this coating involves a complex pre-treatment process ranging from cleaning to sintering. This must be carried out with great care. The coating thickness for use in dynamic applications is 0.020 mm. The level of adhesion of the PTFE layer to the mother material is particularly high.

#### 2. Problem free automatic assembly with O-rings

To avoid O-rings in bulk packaging sticking to each other (possibly causing problems to arise when the rings are used for automatic assembly in mass production) we coat these seals with a thin layer of PTFE. Because large numbers are involved in this type of application price plays an important role.

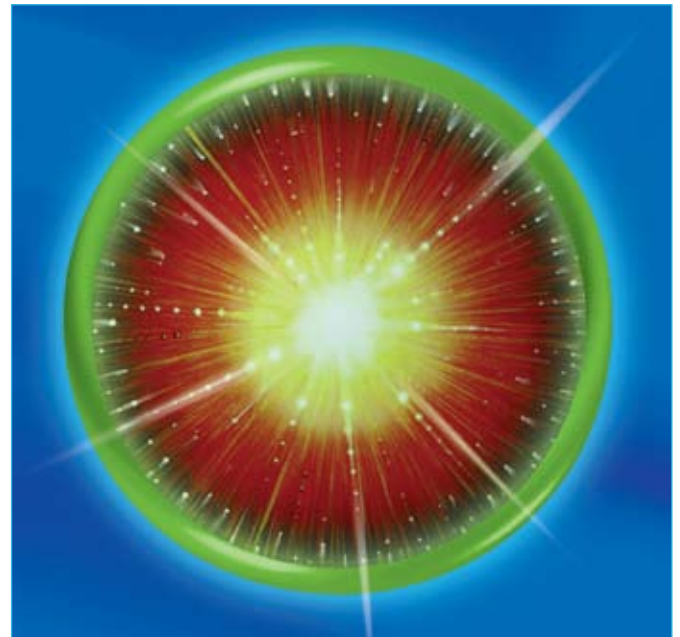

Thus ERIKS has selected dip-spin application and a thickness of approximately 0.005 mm. The coating dries to a splotchy, milky appearance. This coating (SP 10105) is FDA approved in conformance with HHS 21 CFR 175.300 and 177.1520. A polysiloxane coating can also be chosen for this application. However this coating must be spray applied and sintered, so the price is somewhat higher than the thin the PTFE coating mentioned above. On the other hand the polysiloxane provides the smoothest surface. We are continuously developing new coating systems such as our PTFE based SP 10107 - a fully transparent coating for coloured rubber components.

#### 3. Increasing chemical resistance

In many applications PTFE seals are used to resist chemicals in the medium to be sealed. A big disadvantage of PTFE is that it is not resilient and is not always suitable as a sealing material. In many instances the solution is a rubber seal coated with a 0,02 up to 0,03 mm thick PTFE layer. By doing this you combine the outstanding properties of an elastomer (such as the good compression set, tensile strength etc) with those of the chemical resistant PTFE. Products coated with this PTFE based ERIKS 'SurfaPlus' coating have an elongation of at least 100%!

In addition to this frequently used PTFE treatment, a fluoroelastomer coating may also be applied to rubber products to increase chemical resistance. This method is mainly used on very large rubber products made of NBR or EPDM, because it is cheaper than making the entire product from fluoroelastomer. The coating thickness is approximately 0.050 mm.

### 6. Compound Selection - SurfaPlus

#### 4. Surface cleaning ('labsfrei')

In many applications no contamination is allowable, including that from rubber seals. For applications such as the semiconductor industry, food and pharmaceuticals and the automotive industry, seals are thoroughly cleaned using a plasma treatment. Here the surface of the seal is subjected to an ultra-fine cleaning process using a reactive gas under vacuum. Incidentally this process can also be used for treating synthetic materials and metals.

#### 5. Easy cleaning

CIP or SIP are used for cleaning in many processes. Rubber seals coated with 0.020 mm thick PTFE from the ERIKS 'SurfaPlus' rubber surface treatment range are recommended for these methods.

#### Advantages:

- The product that is to be sealed adheres less strongly to the PTFE surface, making cleaning the machine quicker and easier.
- The seal is not damaged by low-pressure cleaning and/or hot water with a cleaning agent.

#### 6. Preventing ageing

NBR products that are coated with PTFE are resistant to the penetration of ozone and UV radiation and thus are very suitable for use in the open air and in electrical equipment.

#### 7. The right colour, easily recognisable and visually attractive

A number of the coatings described can be manufactured in the RAL colour of your choice. This applies particularly to a number of our PTFE coatings and for our fluoroelastomer treatment. These are mainly used in decorative applications.

#### The many advantages of SurfaPlus surface treatment for rubber products

- aids assembly: eases assembly of all rubber products; ideal for automatic assembly of O-rings.
- dry lubrication: improves running characteristics in cases of poor lubrication - even dry running is possible.
- better cleaning: no clinging of product making cleaning easier. Good resistance to SIP and CIP.
- chemical resistance: PTFE based coatings increase the chemical resistance of rubber sheet.
- stops ageing: slower rate of ozone influenced ageing.
- colour: coating with the colour you require is possible if volumes are sufficient.
- FDA approval: PTFE based coatings with FDA approval for food and pharmaceutical products.
- clean room': including making rubber products 'Labsfrei' for automotive, semiconductor and food & pharmaceutical applications.
- flexibility: rubber products with a 'SurfaPlus' coating have 100 to 150% elongation.

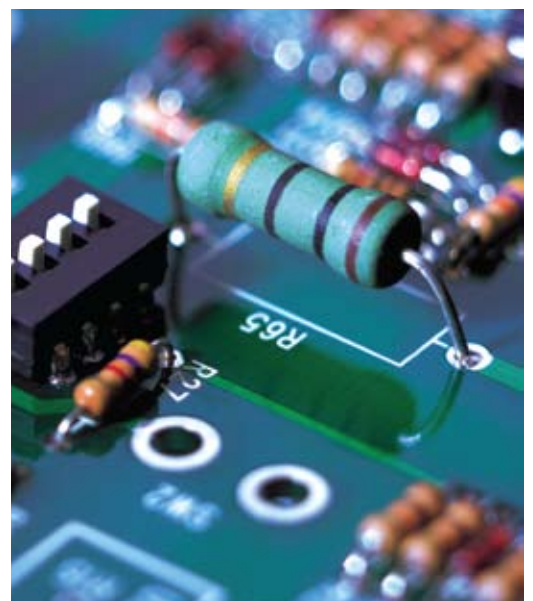
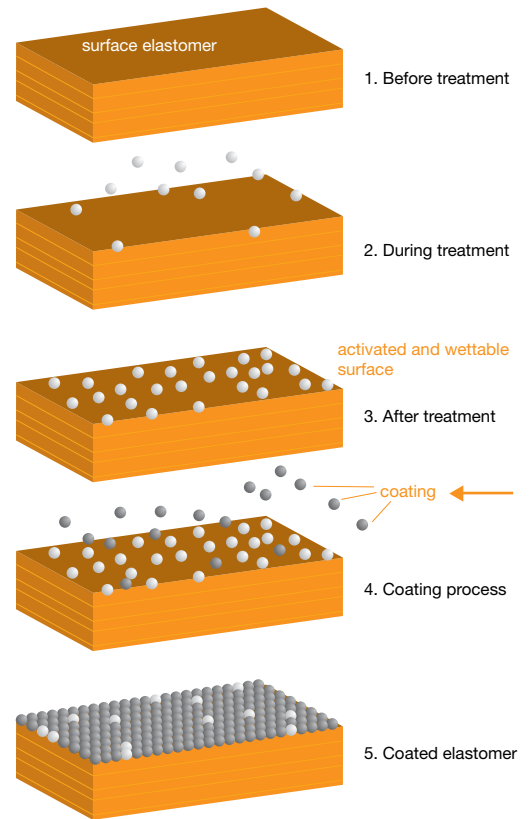

### 6. Compound Selection - SurfaPlus

**Brief summary of the available 'SurfaPlus' surface treatments for rubber products**

ERIKS designation	coating thickness	most common applications	remarks
PTFE	5 mu	to aid assembly, friction reduction for light applications	FDA approval, dries splotchy
PTFE SP 10020	20 mu	to aid assembly, friction reduction in general applications, improving chemical resistance other colours possible	particularly strong coating; for general use; standard colour grey,
Polysiloxan SP 30605	5 mu	to aid assembly, particularly for O-rings and moulded products	provides smoothest surface
Plasma SP 24000	na	cleaning of rubber products, for clean room production, food and pharmaceutical	making 'labsfrei', increases surface hardness by a few Shore points
FKM SP 83050	50 mu	increasing chemical resistance	only viable for very large moulded shapes or profiles, available in several colours
MOS <sub>2</sub> SP 40505	5 mu	to aid assembly, mainly for O-rings	powder coating, easy to apply and economical. Chalks.

Disclaimer:

Not all of the above mentioned surface treatments will show all their benefits on every elastomer.

As with any material, evaluation of any compound and their surface treatment under end-use conditions prior to specification is essential. Since conditions of product use and disposal are outside of our control, we make no warranties, express or implied, and assume no liability in connection with any use of this information. Do not hesitate to contact your local ERIKS application engineer – we will be delighted to be of assistance to you.

### 8. NEW: SurfaPlus® NANO-F:

ERIKS latest technique is a constant further development of already existing surface treatments under consideration of latest technological advances.

This innovative treatment made it possible to engage with the molecular structure of the surface of elastomers. ERIKS is able to change the properties of the surface permanently without alloying the physical properties.

Due to the fact that SURFAPLUS NANO-F is not a coating, the dimensional tolerances of the treated part do not change according to the thickness of a certain coating.

This innovative technique is as well suitable for automatic mounting as for reducing the coefficient of friction.

Even undercuts or complex geometries are no problem – that's why SURFAPLUS NANO-F is also suitable for moulded parts.

This treatment can also be executed on plastics.

At the same time SURFAPLUS NANO-F activates the surface of the treated part – that leads to better results at later glueing, flocking or painting.

Although this is a new and complex technology, ERIKS is able to offer this treatment on a equal price-level in comparison to common coatings and treatments – for low as well as for high volume applications.

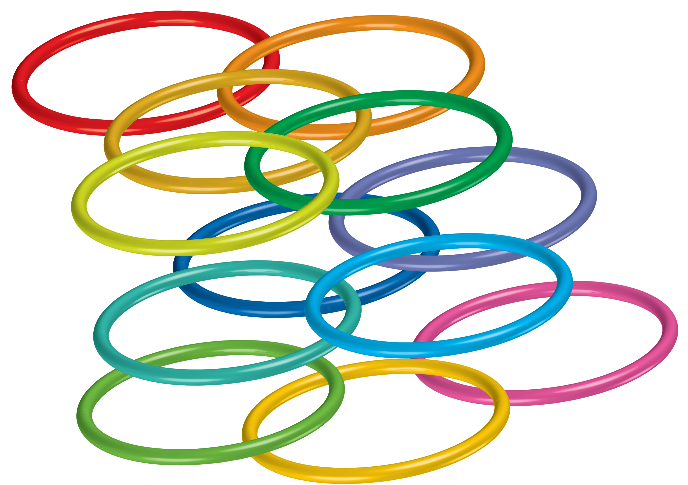

### 6. Compound Selection - Bio-Hygienic®

#### 1. What is Bio-Hygienic®?

A family of pro-active silver filled elastomers which give a continuous protection against microorganisms.

#### Problem

Our world is full of microorganisms. Some are not dangerous and help the digestion; some are in foodproducts like cheese and beer. Others are dangerous and can provoke diseases like MRSA (the hospital bacteria).

Rubberparts and seals are a source for microbial growth due to the fact rubber contains additives which are a breeding ground for microorganisms. These rubberparts are also mainly used in a humid environment, conditions which are ideal for growth.

#### Solution

Bio-Hygienic® compounds contain active silverdiocides which stop the growth of bacteria. As soon as the bacteria or the microbes makes contact with rubber, it absorbs the free silver ions which are at the surface of the rubber. Bio-Hygienic® kills the bacteria or microbes by deterioration of the cellular wall. In addition, the pH-value in the cell is changed in a way that they no longer multiply.

Bio-Hygienic® remains active after a long time even after CIP/SIP cleaning procedures.

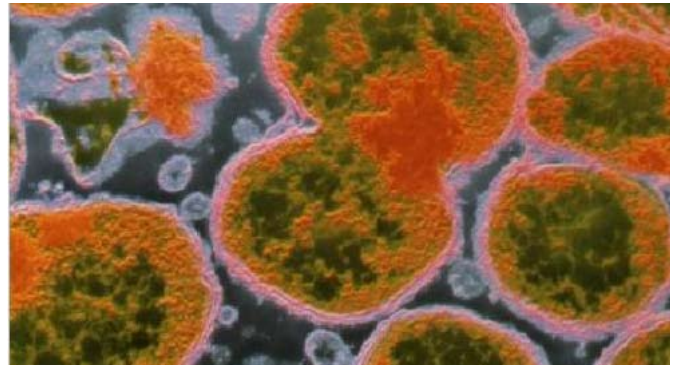

On standard rubber compounds microorganisms develop easily which leads to impurities and odours..



Bio-Hygienic®: the active silverdiocides stop the bacterial growth.

#### Bio-Hygienic® additives are certified by the following bodies:

- FDA Food and Drug Administration
- EPA Environmental protection Agency
- FIFRA Federal Insecticide, Fungicide and rodenticide Act
- EFSA European Food Safety Agency



## 6. Compound Selection - Bio-Hygienic®

### 2. ERIKS standard compounds

Bio-Hygienic® compounds are produced following strict norms certifying an homogenous repartition of the ions. The compounds are frequently tested in our laboratory.

ERIKS offers the following Bio-Hygienic® compounds:

- HNBR 70 shore, auburn, peroxide cured
- EPDM 70 shore, white peroxide cured
- VITON® 70 shore, auburn
- MVQ Silicone 70 shore, transparent FDA
- MVQ Silicone 70 shore, transparent USP

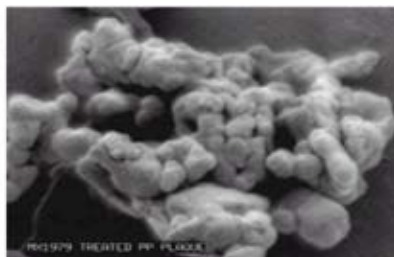

Bacterial growth...

... not anymore with Bio-Hygienic®!

### 3. Advantages of Bio-Hygienic®

- The silver ions remain active after many cleaning procedures
- Seals are often located where CIP/SIP hardly comes. With Bio-Hygienic® this potential threat is covered
- Low maintenance costs
- Odourless, tasteless
- Withstand up to 200°C depending on the compound
- Can be manufactured in many forms

### 6. Compound Selection - Bio-Hygienic®

#### 4. Delivery program

- Sanitary seals for DIN 11851
- Inflatable seals
- TPeRX® profiles
- O-rings
- Custom made rubberparts
- Tri-Clover fittings
- Hoses in rubber and PUR



 biohygienic®